

MORE SENATOR. MORE YOU.

PENS AND MUGS
Catalogue 2017



senator[®]
Extramoreordinary. Since 1920.

Dear Senator Group Business Partners,

We have now considered ourselves as a strong promotional product trade partner for almost one hundred years. Writing instruments, and also mugs and tumblers, are our passion.

The term "extramordinary" summarises our mission. With our work, we want to do justice to this claim:

- by offering you an outstanding product portfolio with innumerable customisation options - we will do everything in our power to present the brands of your customers in the best possible way.
- by basing our company in Groß-Bieberau in order to demonstrate our commitment to Germany as a business location with an extremely high value creation potential - an excellent team and tried-and-tested processes help us to deliver you top quality.
- by being fast and reliable - we contribute our close proximity to the market and the fact that our technical equipment allows us to respond to specific requirements even at short notice to our cooperation.

We do all of this with the aim of ensuring your satisfaction in the hope that you will recommend us, because we have only done our job well if your customers associate you positively with your promotional products in the form of writing instruments, mugs and tumblers.

That is what inspires us every day, time and again.

Yours,

Daniel Jeschonowski
Managing Director, Senator GmbH

PS: Once again, we are delighted to be able to present several interesting new products in 2017, including one metal and one plastic writing instrument "Made in Germany". Please read on and have a look at the following pages, where you will also find all of the products which we can customise and have ready for dispatch to you within five days. This service is of course not subject to any extra charges!



NEW

2017 PRODUCT NEWS



BRIDGE

**MORE
VARIETY.
MORE
CHOICE.**

The ultra-smooth twist-action ballpen that bridges the gap between quality and affordability. With a large clip sporting an advantageous print area, and 15 colours in both transparent and polished surfaces, (optionally equipped with a metal tip), the Bridge range of promotional pens is the optimum solution for your company.

PAGE 13



POLAR

**MORE
QUALITY.
MORE
BENEFIT.**

Luxe for Less; the Polar retractable ball pen range combines German production quality with a stylish European design, all at a favourable price.

PAGE 53

OUR SENATOR RANGE

Contents

PLASTIC PENS

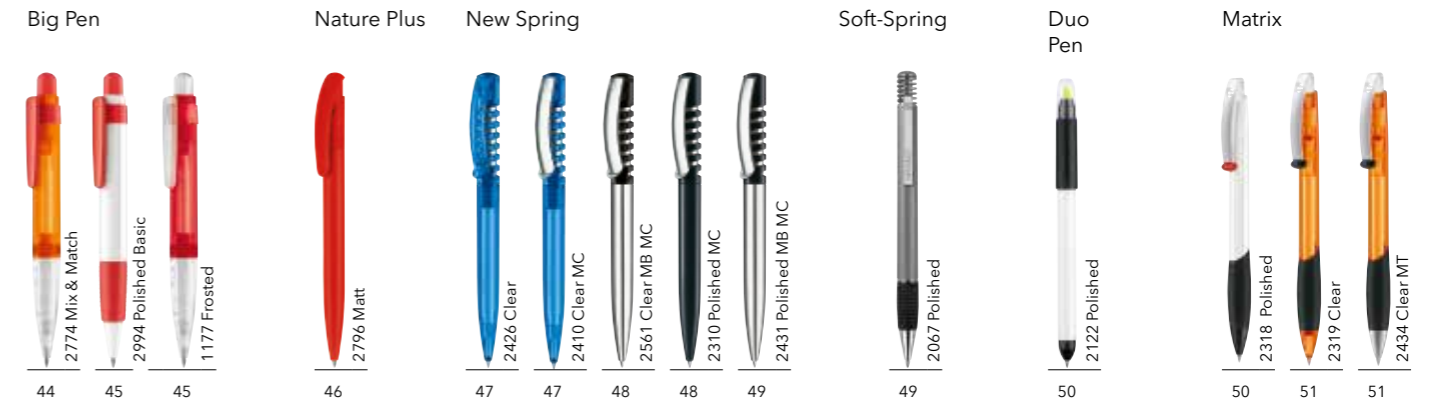
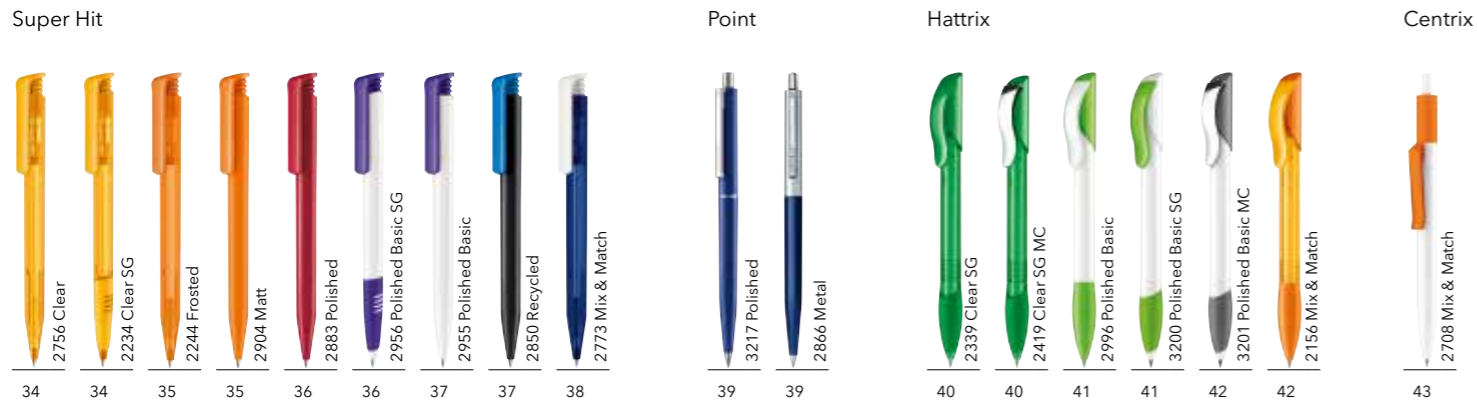
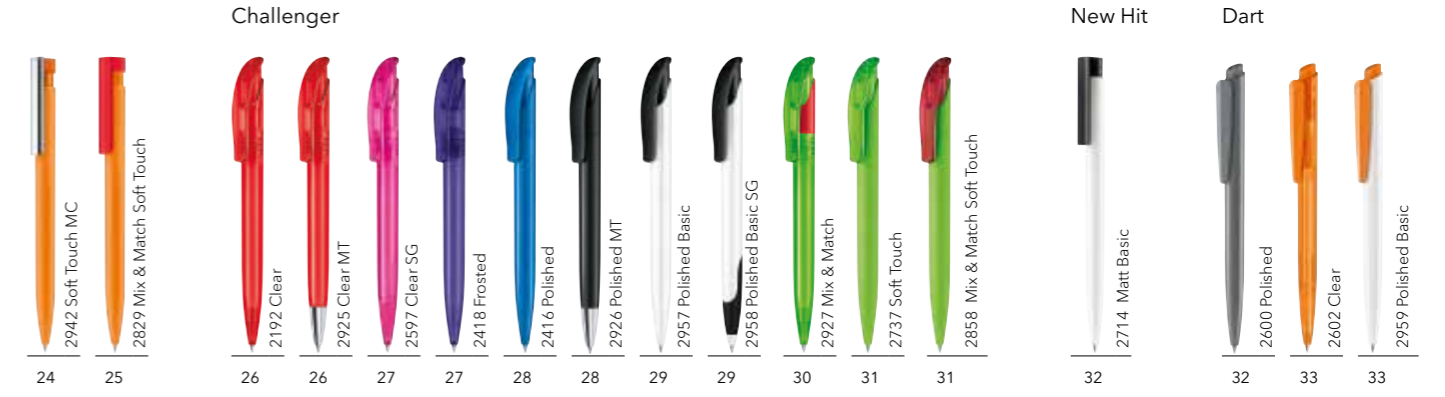
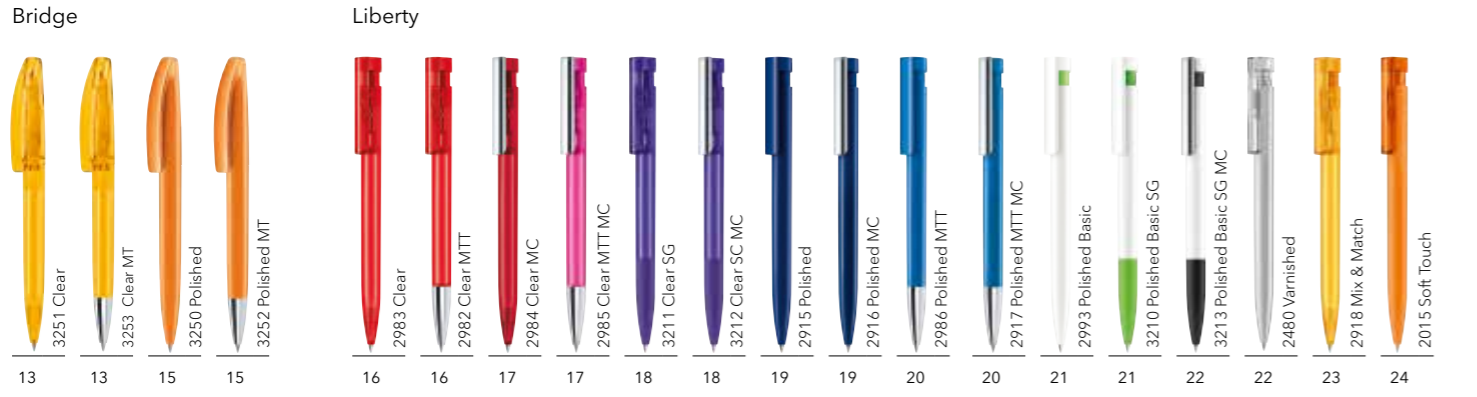

METAL PENS

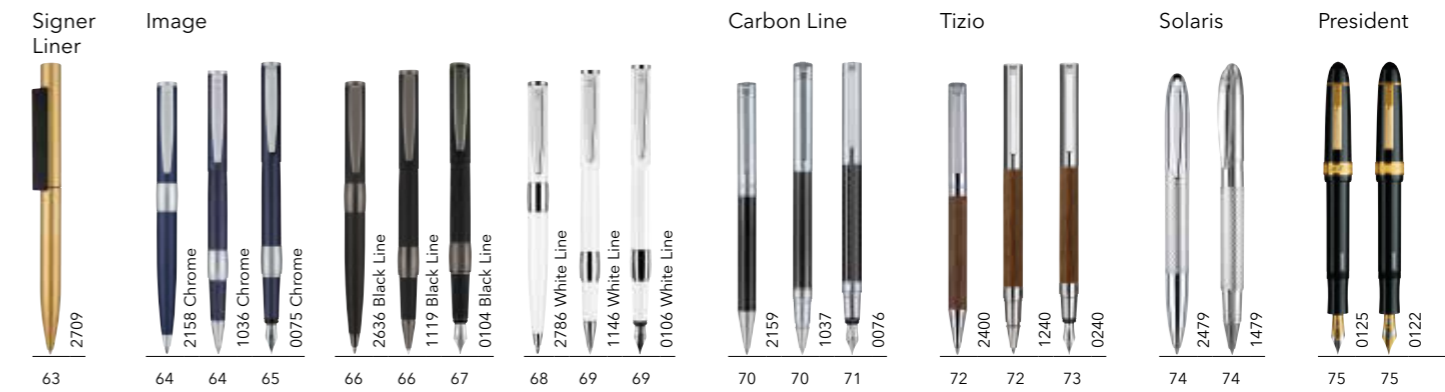

CASES

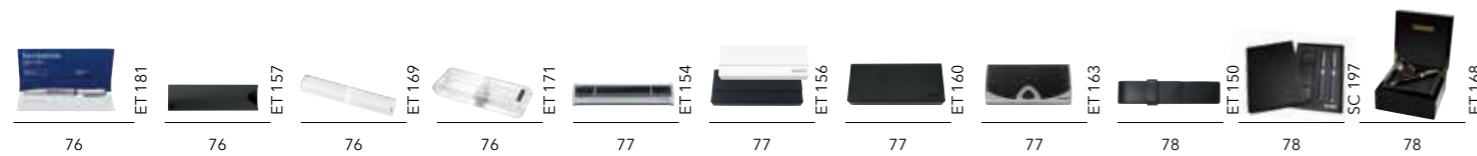

SERVICES

Branding Methods	PMS Service	Refills
108	112	113

OUR SENATOR RANGE

Contents

SUBLIMATION MUGS

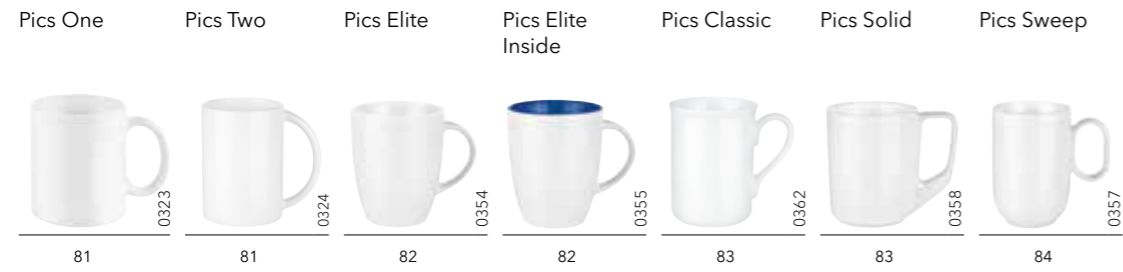

TO GO

GLASS



MUGS

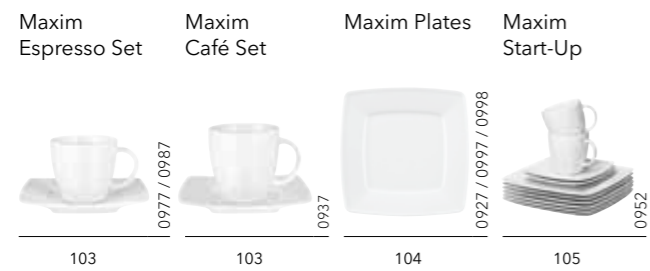
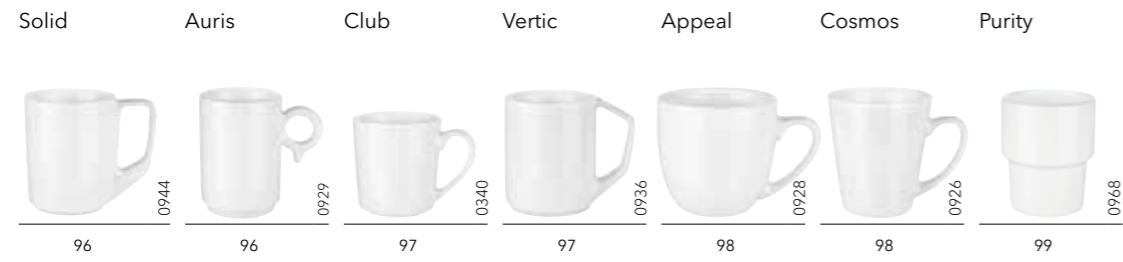
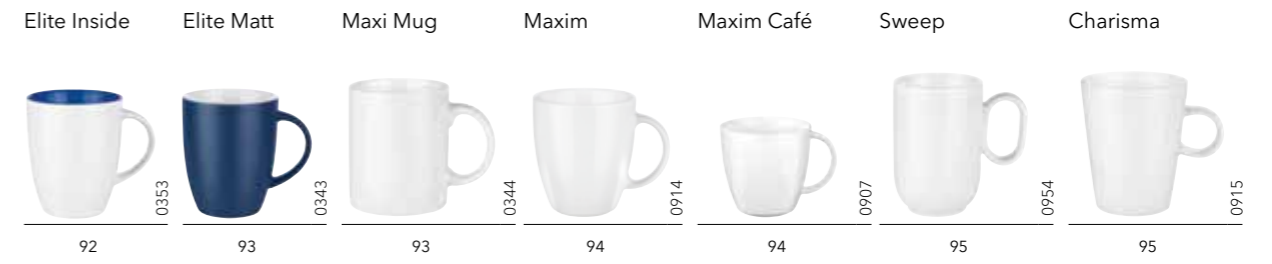
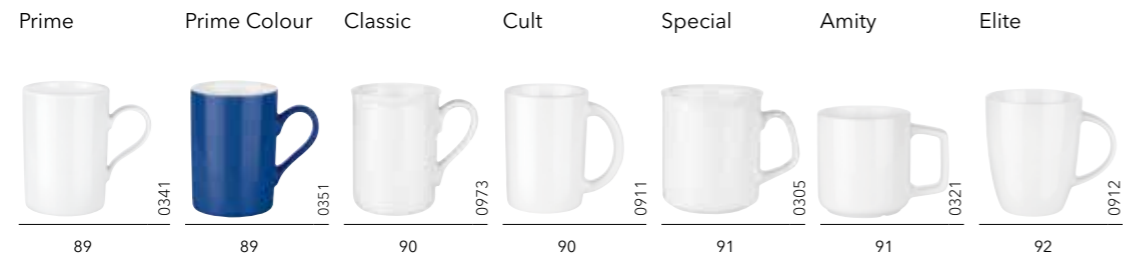

SETS

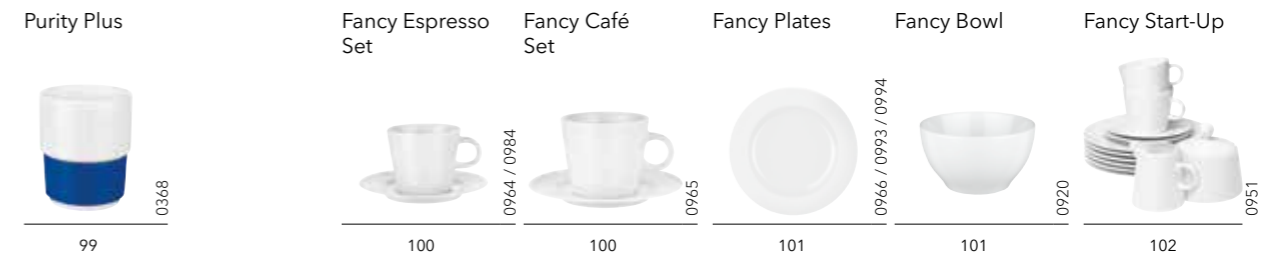

SERVICES

Packaging	Branding Methods
106	110

WHY SENATOR?



MADE IN GERMANY

Made in Germany is synonymous with quality, reliability and confidence. We have over 95 years of experience and are "the" specialist in writing instruments and mugs. We know how great products look, function and need to be printed to make them into high class and long-lasting promotional products.

All senator® products are strictly quality controlled.

All products that are direct from our German production are marked with this logo.



SENATOR HIGH DEFINITION PRINT

The worldwide unique senator® High Definition Print opens nearly unlimited chances in staging your message. This specific branding method is available for all ball pens that are marked with this logo.

For more details please refer to page 108.



WHY SENATOR?



OUR EXPRESS DELIVERY SERVICES

We are market leader in delivery speed. Senator® produces and prints up to 5,000 writing instruments in 5 days. If you need the pens in 2 days our Pen Express is the solution. If you are looking for quick, flexible and high-quality solutions, then that's what we'll deliver. Left it to the last minute? We'll make time!

For all products marked with these logos we offer:

5000 IN 5

- up to 5,000 ball pens
- printed with up to 5 colours
- ready for dispatch within 5 days (from conformation of print sketch)
- without surcharge

For detailed product information please refer to the following page.

PEN EXPRESS

- up to 1,000 ball pens
- printed with one colour (barrel print)
- ready for dispatch within 2 days (from conformation of print sketch)
- against surcharge

For detailed product information please refer to the following page.



AWARDED DESIGNS

Almost no other vendor has so many award-winning products. We've won the Red Dot Design Award, Promotional Gift Award and many more. For every brand and every message we have a solution to increase your advertising impact.

CERTIFIED SECURITY

We only deliver products that we can guarantee fulfil all statutory requirements. Choosing us means making a commitment to reliable, sustainable products of qualitativ high quality. External auditors also repeatedly attest to that; we've been certified according to ISO 9001, 14001, BSCI oder auch SEDEX (UK).



EXPRESS DELIVERY SERVICE

5000 in 5



Liberty Polished Basic 2993
 Dart Polished Basic 2959
 Super Hit Polished Basic 2955
 Challenger Polished Basic 2957



Bridge Polished 3250
 Clear 3251
 Liberty Polished 2915
 Clear 2983
 Clear SG 3211

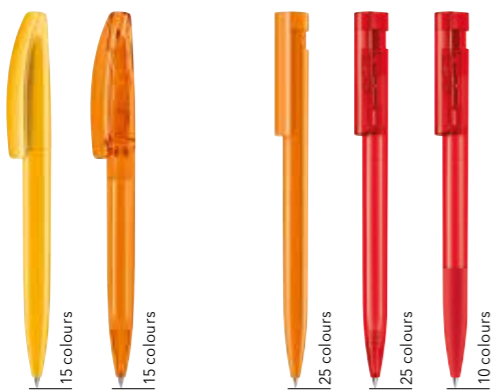

Dart Polished 2600
 Clear 2602
 Challenger Polished 2416
 Frosted 2418
 Clear 2192
 Clear SG 2597



5,000 BALL PENS IN 5 DAYS

For our most popular products we deliver as standard without surcharge:

- 5 days production time from confirmation of print sketch
- up to 5,000 ball pens
- printed with up to 5 colours (1 branding position, branding type A and C)
- valid for all colours of the respective product
- all models available with blue or black ink refill

10 COLOURS

Our Polished Basic products Liberty, Dart, Super Hit and Challenger as well as Liberty Clear SG are available in these 10 bright colours.

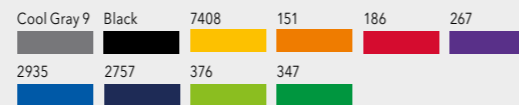

15 COLOURS

All uni-colour products are available in 15 different colours. An exception to this rule are our products with soft grip section which are not available in white as well as Liberty Polished and Liberty Clear which both are available in 25 colours.

For photos of all products in each available colour please refer to the respective product page in this catalogue.

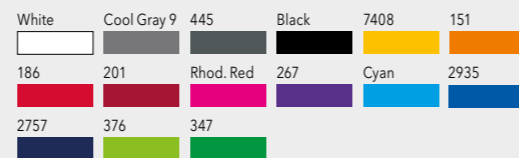

Super Hit Polished 2883
 Matt 2904
 Frosted 2244
 Clear 2756
 Clear SG 2234



EXPRESS DELIVERY SERVICE

Pen Express



1,000 PENS IN 2 DAYS

If you need your pens even faster our Pen Express service is the solution:

- only 2 days production from confirmation of print sketch
- up to 1,000 ball pens in 6 colours
- printed in 1 colour (barrel print, 1 print position)
- blue ink refill
- against surcharge

6 COLOURS

Pen Express is available for 6 models in 6 strong promotion colours:

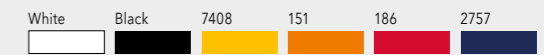

Super Hit Polished Basic 2957
 Polished 2883
 Frosted 2244



Dart Polished Basic 2959
 Polished 2600
 Challenger Frosted 2418





NEW



BRIDGE CLEAR

MORE TRANSPARENCY. MORE RESULTS.

A unique striking design with a high gloss transparent finish: **Bridge Clear**. If you are looking for a promotional pen with a difference, you will hardly be able to resist the colourful clarity of the new Bridge Clear. The design shows a genuine love of detail and elegantly emphasises advertising slogans, yet does not overpower them, guaranteeing successful advertising.

BRIDGE Clear

NEW

MADE GERMANY

5000 IN 5



3251 3251

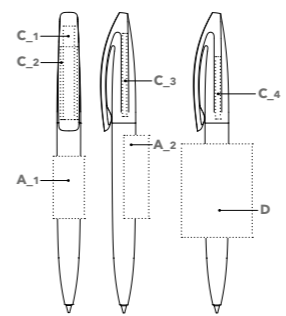

Art. No 3251
Twist ball pen
Glossy transparent body and clip surface,
senator® magic flow G2 refill (1.0 mm)
ink colour: blue or black

SERVICES
5,000 in 5, see page 10
PMS Service: from 10,000 pieces, see page 112



BRANDING / AREA

A_1 Screen print	30 x 15 mm	C_3 Tampo print	40 x 2 mm
A_2 Screen print	40 x 12 mm	C_4 Tampo print	30 x 3 mm
C_1 Tampo print	45 x 5 mm	D Barrel print 360°	45 x 34 mm
C_2 Tampo print	35 x 8 mm		

BRIDGE Clear MT

NEW

MADE GERMANY



3253 3253

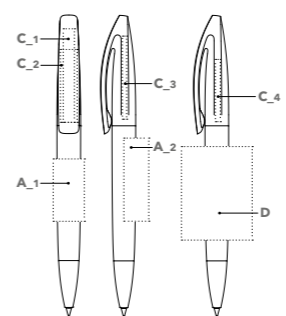

Art. No 3253
Twist ball pen
Glossy transparent body and clip surface,
glossy metal tip,
senator® magic flow G2 refill (1.0 mm)
ink colour: blue or black

SERVICES
PMS Service: from 10,000 pieces, see page 112



BRANDING / AREA

A_1 Screen print	30 x 15 mm	C_3 Tampo print	40 x 2 mm
A_2 Screen print	40 x 12 mm	C_4 Tampo print	30 x 3 mm
C_1 Tampo print	45 x 5 mm	D Barrel print 360°	45 x 34 mm
C_2 Tampo print	35 x 8 mm		

PLASTIC PENS

METAL PENS

MUGS

SERVICES



NEW



BRIDGE POLISHED

MORE EXPRESSION. MORE RESPONSE.

Striking and communicative: **Bridge Polished**. Strong, rich colours and an elegant design with a genuine love of detail result in a ballpoint pen with character. Together, its elegance and linearity effortlessly bridge the gap between a pen with a promotional purpose and a desirable product with its own personality.

BRIDGE Polished

NEW

MADE GERMANY

5000 IN 5

HD PRINT

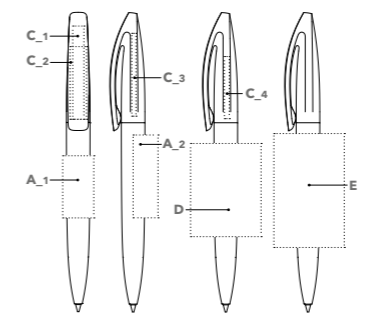

Art. No 3250
Twist ball pen
Glossy opaque body and clip surface,
senator® magic flow G2 refill (1.0 mm)
ink colour: blue or black

SERVICES
5,000 in 5, see page 10
PMS Service: from 10,000 pieces, see page 112



BRANDING / AREA

A_1 Screen print	30 x 15 mm	C_3 Tampo print	40 x 2 mm
A_2 Screen print	40 x 12 mm	C_4 Tampo print	30 x 3 mm
C_1 Tampo print	45 x 5 mm	D Barrel print 360°	45 x 34 mm
C_2 Tampo print	35 x 8 mm	E HD print 360° on white barrel	55 x 34 mm

BRIDGE Polished MT

NEW

MADE GERMANY

HD PRINT

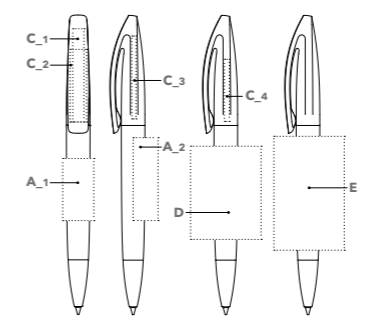

Art. No 3252
Twist ball pen
Glossy opaque body and clip surface,
glossy metal tip,
senator® magic flow G2 refill (1.0 mm)
ink colour: blue or black

SERVICES
PMS Service: from 10,000 pieces, see page 112



BRANDING / AREA

A_1 Screen print	30 x 15 mm	C_3 Tampo print	40 x 2 mm
A_2 Screen print	40 x 12 mm	C_4 Tampo print	30 x 3 mm
C_1 Tampo print	45 x 5 mm	D Barrel print 360°	45 x 34 mm
C_2 Tampo print	35 x 8 mm	E HD print 360° on white barrel	55 x 34 mm

PLASTIC PENS

METAL PENS

MUGS

SERVICES

LIBERTY® Clear

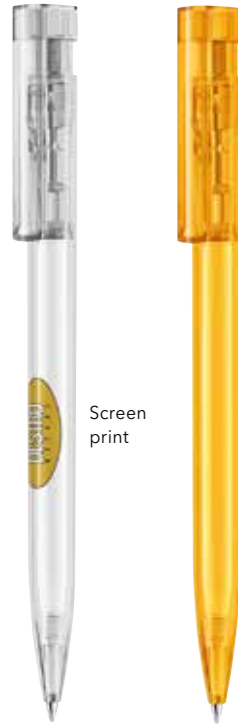

2983 2983

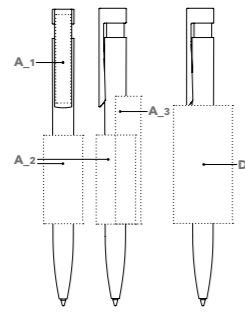

Art. No 2983

Push ball pen
Glossy transparent body and clip surface,
senator® magic flow G2 refill (1.0 mm)
ink colour: blue or black

SERVICES

5,000 in 5, see page 10
PMS Service: from 10,000 pieces,
see page 112

COLOURS



BRANDING / AREA

A_1	Screen print	40 x 6 mm	A_3	Screen print	65 x 13 mm
A_2	Screen print	45 x 20 mm	D	Barrel print 360°	60 x 30 mm

LIBERTY® Clear MC



2984 2984

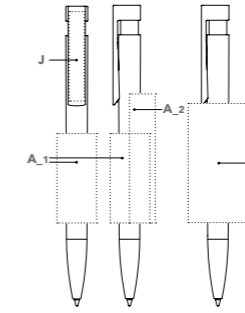

Art. No 2984

Push ball pen
Glossy transparent body surface, metal clip,
senator® magic flow G2 refill (1.0 mm)
ink colour: blue or black

SERVICES

PMS Service: from 10,000 pieces, see page 112

COLOURS



BRANDING / AREA

A_1	Screen print	45 x 20 mm	D	Barrel print 360°	60 x 30 mm
A_2	Screen print	65 x 13 mm	J	Laser engraving	45 x 6 mm

LIBERTY® Clear MTT



2982 2982

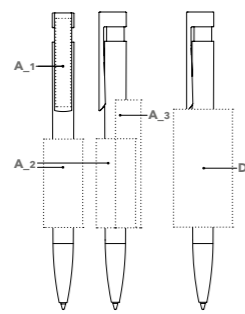

Art. No 2982

Push ball pen
Glossy transparent body and clip surface,
metallised tip,
senator® magic flow G2 refill (1.0 mm)
ink colour: blue or black

SERVICES

PMS Service: from 10,000 pieces, see page 112

COLOURS



BRANDING / AREA

A_1	Screen print	40 x 6 mm	A_3	Screen print	65 x 13 mm
A_2	Screen print	45 x 20 mm	D	Barrel print 360°	60 x 30 mm

LIBERTY® Clear MTT MC

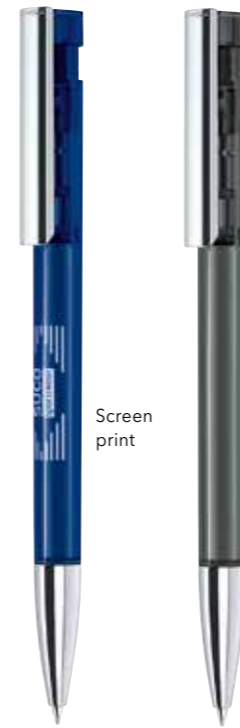

2985 2985

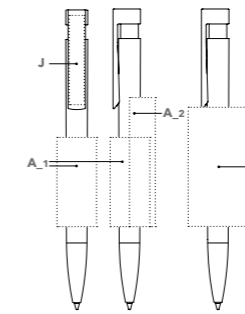

Art. No 2985

Push ball pen
Glossy transparent body surface,
metallised tip, metal clip,
senator® magic flow G2 refill (1.0 mm)
ink colour: blue or black

SERVICES

PMS Service: from 10,000 pieces, see page 112

COLOURS



BRANDING / AREA

A_1	Screen print	45 x 20 mm	D	Barrel print 360°	60 x 30 mm
A_2	Screen print	65 x 13 mm	J	Laser engraving	45 x 6 mm

LIBERTY® Clear SG

NEW

MADE IN GERMANY

5000 IN 5

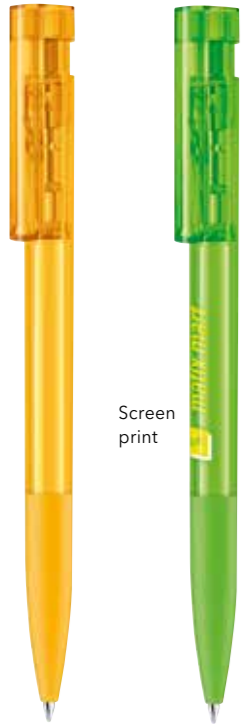

3211

3211

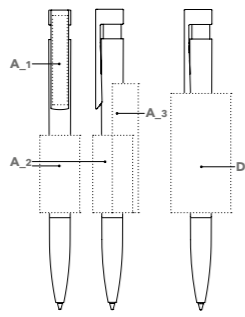

Art. No 3211

Push ball pen
Glossy transparent body and clip surface,
coloured soft grip zone matching the barrel,
senator® magic flow G2 refill (1.0 mm)
ink colour: blue or black

SERVICES

5,000 in 5, see page 10
PMS Service: from 40,000 pieces, see page 112

COLOURS



BRANDING / AREA

A_1	Screen print	40 x 6 mm	D	Barrel print 360°	60 x 30 mm
A_2	Screen print	39 x 20 mm			
A_3	Screen print	65 x 13 mm			

LIBERTY® Polished

MADE IN GERMANY

5000 IN 5

HD PRINT



2915

2915

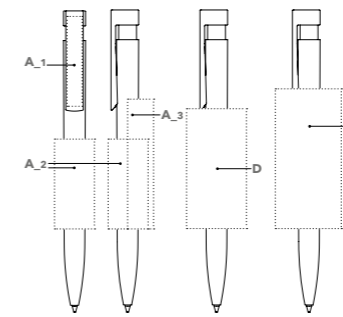

Art. No 2915

Push ball pen
Glossy opaque body and clip surface,
senator® magic flow G2 refill (1.0 mm)
ink colour: blue or black

SERVICES

5,000 in 5, see page 10
PMS Service: from 10,000 pieces,
see page 112

COLOURS

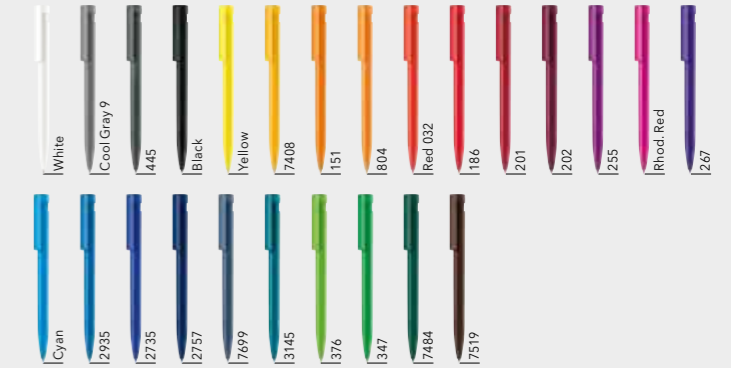

BRANDING / AREA

A_1	Screen print	40 x 6 mm	D	Barrel print 360°	60 x 30 mm
A_2	Screen print	45 x 20 mm	E	HD print 360° on white barrel	70 x 33 mm
A_3	Screen print	65 x 13 mm			

LIBERTY® Clear SG MC

NEW

MADE IN GERMANY

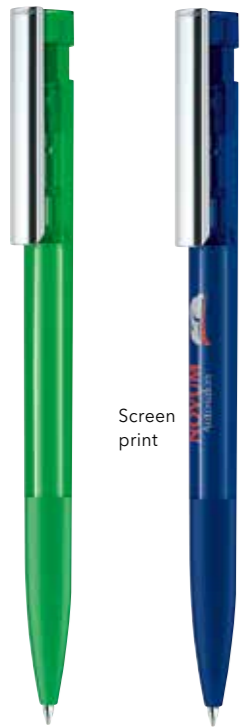

3212

3212

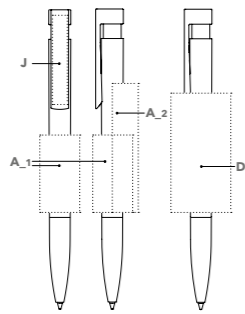

Art. No 3212

Push ball pen
Glossy transparent body and clip surface,
coloured soft grip zone matching the barrel,
metal clip,
senator® magic flow G2 refill (1.0 mm)
ink colour: blue or black

SERVICES

PMS Service: from 40,000 pieces, see page 112

COLOURS

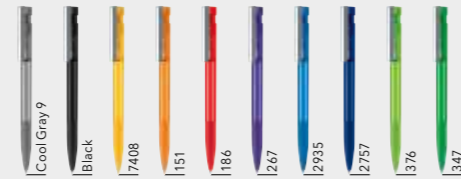

BRANDING / AREA

A_1	Screen print	39 x 20 mm	D	Barrel print 360°	60 x 30 mm
A_2	Screen print	65 x 13 mm	J	Laser engraving	45 x 6 mm

LIBERTY® Polished MC

MADE IN GERMANY

HD PRINT

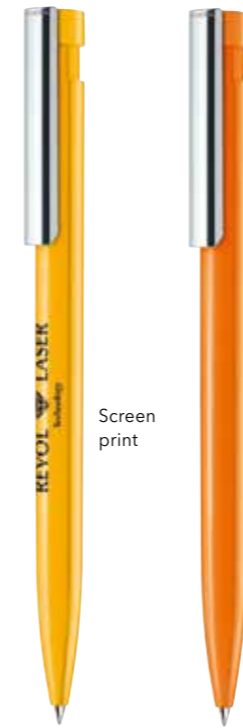

2916

2916

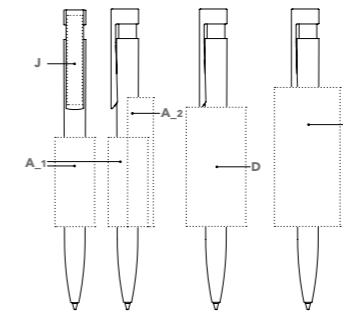

Art. No 2916

Push ball pen
Glossy opaque body surface, metal clip,
senator® magic flow G2 refill (1.0 mm)
ink colour: blue or black

SERVICES

PMS Service: from 10,000 pieces, see page 112

COLOURS

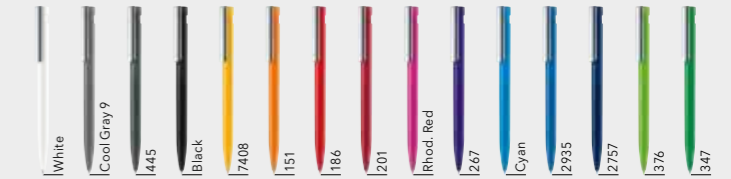

BRANDING / AREA

A_1	Screen print	45 x 20 mm	E	HD print 360° on white barrel	70 x 33 mm
A_2	Screen print	65 x 13 mm	J	Laser engraving	45 x 6 mm
D	Barrel print 360°	60 x 30 mm			

LIBERTY® Polished MTT

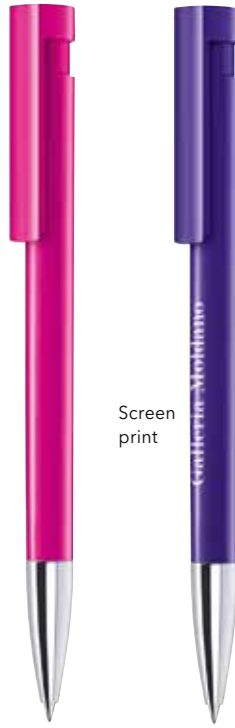

2986 2986

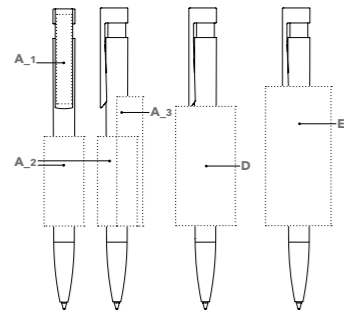

Art. No 2986

Push ball pen
Glossy opaque body and clip surface,
metallised tip,
senator® magic flow G2 refill (1.0 mm)
ink colour: blue or black

SERVICES

PMS Service: from 10,000 pieces, see page 112

COLOURS

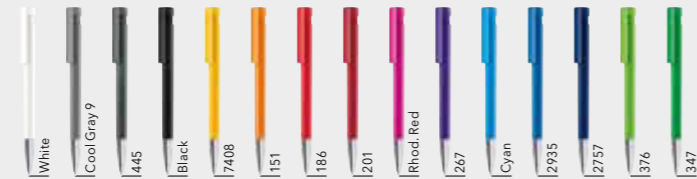

BRANDING / AREA

A_1 Screen print	40 x 6 mm	D Barrel print 360°	60 x 30 mm
A_2 Screen print	45 x 20 mm	E HD print 360° on white barrel	70 x 33 mm
A_3 Screen print	65 x 13 mm		

LIBERTY® Polished Basic



2993 2993

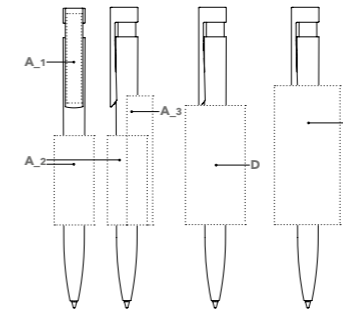

Art. No 2993

Push ball pen
Glossy opaque body and clip surface, white
barrel, coloured transparent mid part,
senator® magic flow G2 refill (1.0 mm)
ink colour: blue or black

SERVICES

5,000 in 5, see page 10
PMS Service: from 10,000 pieces, see page 112

COLOURS

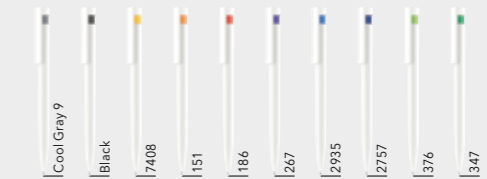

BRANDING / AREA

A_1 Screen print	40 x 6 mm	D Barrel print 360°	60 x 30 mm
A_2 Screen print	45 x 20 mm	E HD print 360°	70 x 33 mm
A_3 Screen print	65 x 13 mm		

LIBERTY® Polished MTT MC



2917 2917

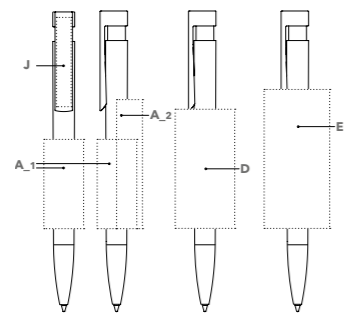

Art. No 2917

Push ball pen
Glossy opaque body surface, metallised tip,
metal clip,
senator® magic flow G2 refill (1.0 mm)
ink colour: blue or black

SERVICES

PMS Service: from 10,000 pieces, see page 112

COLOURS

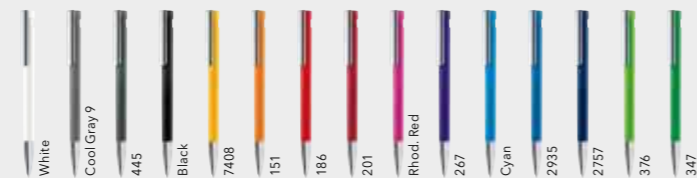

BRANDING / AREA

A_1 Screen print	45 x 20 mm	E HD print 360° on white barrel	70 x 33 mm
A_2 Screen print	65 x 13 mm	J Laser engraving	45 x 6 mm
D Barrel print 360°	60 x 30 mm		

LIBERTY® Polished Basic SG



3210 3210

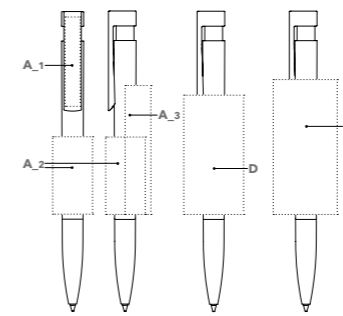

Art. No 3210

Push ball pen
Glossy opaque body and clip surface, white
barrel, coloured soft grip zone matching
the mid part,
senator® magic flow G2 refill (1.0 mm)
ink colour: blue or black

SERVICES

PMS Service: from 40,000 pieces, see page 112

COLOURS

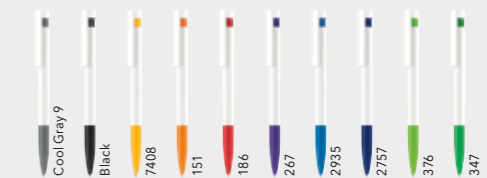

BRANDING / AREA

A_1 Screen print	40 x 6 mm	D Barrel print 360°	60 x 30 mm
A_2 Screen print	39 x 20 mm	E HD print 360°	68 x 33 mm
A_3 Screen print	65 x 13 mm		

LIBERTY® Polished Basic SG MC

NEW

MADE IN GERMANY

HD PRINT

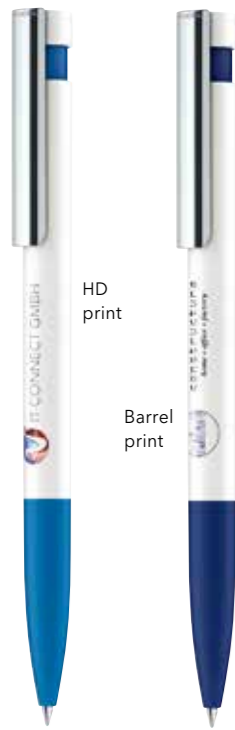

3213 3213

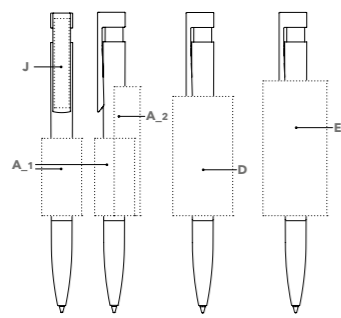

Art. No 3213

Push ball pen
Glossy opaque body and clip surface, white barrel, coloured soft grip zone matching the mid part, metal clip, senator® magic flow G2 refill (1.0 mm) ink colour: blue or black

SERVICES

PMS Service: from 40,000 pieces, see page 112

COLOURS

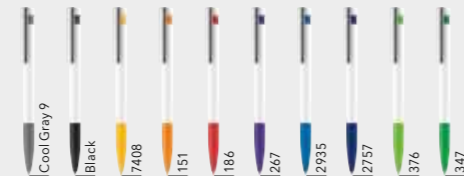

BRANDING / AREA

A_1	Screen print	39 x 20 mm	E	HD print 360°	68 x 33 mm
A_2	Screen print	65 x 13 mm	J	Laser engraving	45 x 6 mm
D	Barrel print 360°	60 x 30 mm			

LIBERTY® Mix & Match

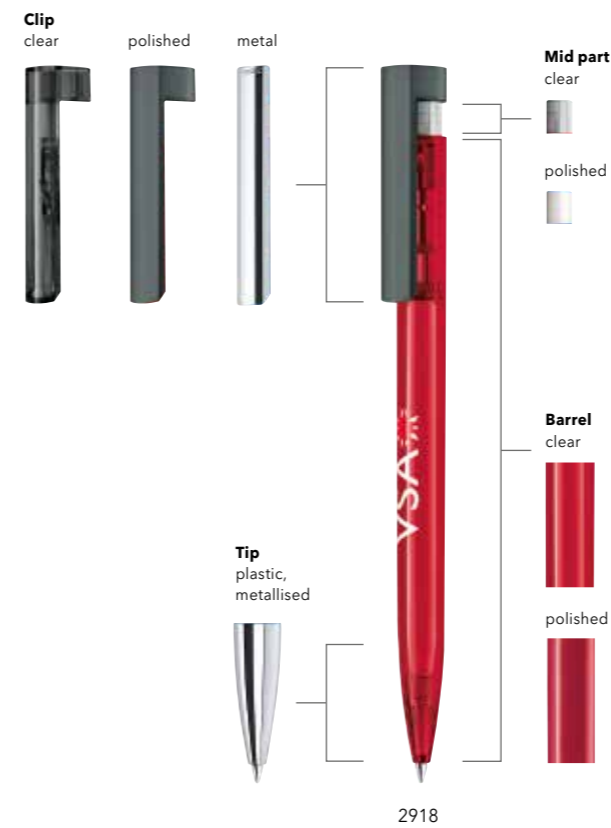

2918

Art. No 2918

Push ball pen
Free combination option of different parts (barrel, mid, clip), surfaces (clear or polished), accessories (metallised tip or metal clip) and colours, senator® magic flow G2 refill (1.0 mm) ink colour: blue or black

SERVICES

PMS Service: from 10,000 pieces, see page 112

Additional refill option:
Senator magic flow refill 1.4

COLOURS

Clip
clear, polished

Mid part
clear, polished

Barrel
clear, polished

Clear/White	Cool Gray 9	445	Black	Yellow	7408	151	804
Red 032	186	201	202	255	Rhod. Red	267	Cyan
2935	2735	2757	7699	3145	376	347	7484
7519							

Clip metal
with clip holder clear, polished

Clear/White	Cool Gray 9	445	Black	7408	151	186	201
Rhod. Red	267	Cyan	2935	2757	376	347	

Barrel with metallised tip
clear, polished

White	Cool Gray 9	445	Black	7408	151	186	201
Rhod. Red	267	Cyan	2935	2757	376	347	

LIBERTY® Varnished Metallic

MADE IN GERMANY



2480 2480

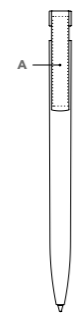

Art. No 2480

Push ball pen
Metal lacquered body surface, transparent clip, senator® magic flow G2 refill (1.0 mm) ink colour: blue or black

SERVICES

PMS Service: from 10,000 pieces, see page 112

COLOURS



BRANDING / AREA

A	Screen print	40 x 6 mm
----------	--------------	-----------

EXAMPLE



2918 2918

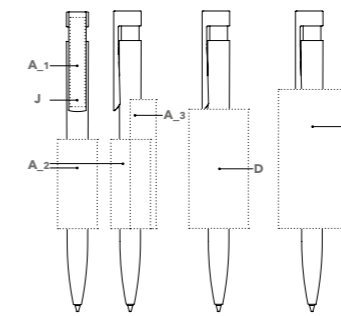

BRANDING / AREA

A_1	Screen print	40 x 6 mm	D	Barrel print 360°	60 x 30 mm
A_2	Screen print	45 x 20 mm	E	HD print 360° on white barrel	70 x 33 mm
A_3	Screen print	65 x 13 mm	J	Metal clip: Laser engraving	45 x 6 mm

LIBERTY® Soft Touch

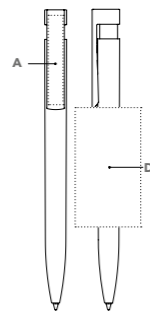

Art. No 2015

Push ball pen
Velvety body surface, glossy transparent mid, glossy transparent clip,
senator® magic flow G2 refill (1.0 mm)
ink colour: blue or black

SERVICES

PMS Service: from 10,000 pieces, see page 112

COLOURS



BRANDING / AREA

A Screen print 40 x 6 mm D Barrel print 360° 60 x 30 mm

LIBERTY® Soft Touch MC

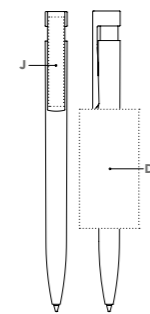
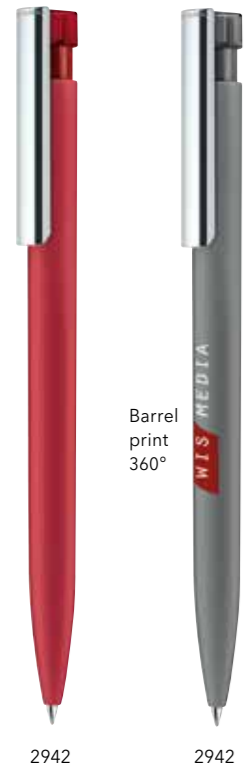

Art. No 2942

Push ball pen
Velvety surface, transparent mid part,
metal clip,
senator® magic flow G2 refill (1.0 mm)
ink colour: blue or black

SERVICES

PMS Service: from 10,000 pieces, see page 112

COLOURS



BRANDING / AREA

D Barrel print 360° 60 x 30 mm J Laser engraving 45 x 6 mm

LIBERTY® Mix & Match (Soft Touch)

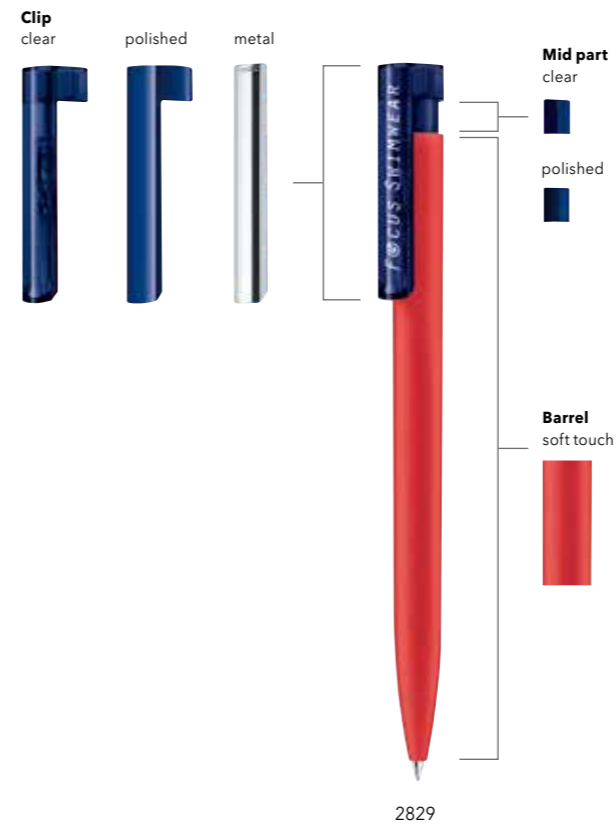

EXAMPLE

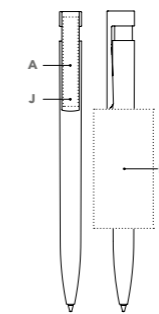

Art. No 2829

Push ball pen
Velvety body surface + free combination
option of different parts (mid, clip), surfaces
(clear or polished) and colours,
senator® magic flow G2 refill (1.0 mm)
ink colour: blue or black

SERVICES

PMS Service: from 10,000 pieces,
see page 112

Additional refill option:
Senator magic flow refill 1.4

COLOURS

Clip

clear, polished

Clear/White	Cool Gray 9	445	Black	Yellow	7408	151	804
Red 032	186	201	202	255	Rhod. Red	267	Cyan
2935	2735	2757	7699	3145	376	347	7484
7519							

Clip metal

with clip holder clear, polished

White	Cool Gray 9	445	Black	7408	151	186	201
Rhod. Red	267	Cyan	2935	2757	376	347	

Mid part

clear, polished

Clear/White	Cool Gray 9	445	Black	Yellow	7408	151	804
Red 032	186	201	202	255	Rhod. Red	267	Cyan
2935	2735	2757	7699	3145	376	347	7484
7519							

Barrel

soft touch

White	Cool Gray 9	445	Black	Yellow	7408	151	804
Red 032	186	201	202	255	Rhod. Red	267	Cyan
2935	2735	2757	7699	3145	376	347	7484
7519							

BRANDING / AREA

A Screen print 40 x 6 mm J Metal clip: Laser engraving 45 x 6 mm

D Barrel print 360° 60 x 30 mm

CHALLENGER Clear



2192 2192

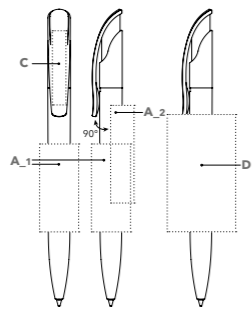

Art. No 2192

Push ball pen
Glossy transparent body and clip surface,
senator® magic flow G2 refill (1.0 mm)
ink colour: blue or black

SERVICES

5,000 in 5, see page 10
PMS Service: from 10,000 pieces, see page 112

COLOURS

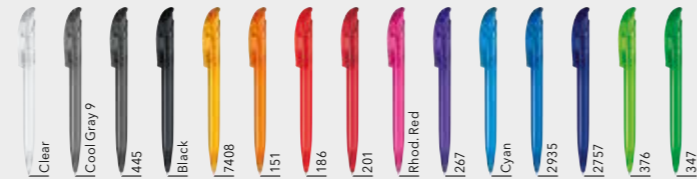

BRANDING / AREA

A_1	Screen print	45 x 20 mm	C	Tampo print	35 x 7 mm or 40 x 5 mm
A_2	Screen print	50 x 12 mm	D	Barrel print 360°	60 x 35 mm

CHALLENGER Clear SG



2597 2597

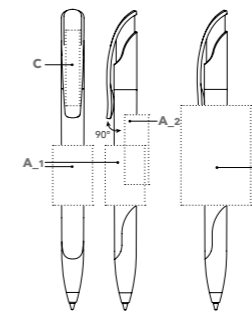

Art. No 2597

Push ball pen
Glossy transparent body and clip surface,
coloured soft grip zone matching the barrel,
senator® magic flow G2 refill (1.0 mm)
ink colour: blue or black

SERVICES

5,000 in 5, see page 10
PMS Service: from 30,000 pieces, see page 112

COLOURS

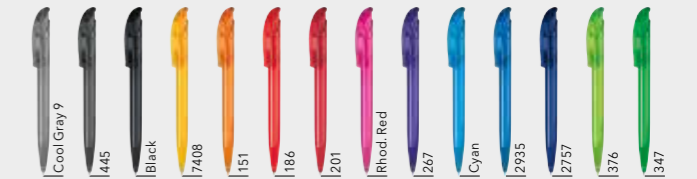

BRANDING / AREA

A_1	Screen print	30 x 20 mm or 45 x 10 mm	C	Tampo print	35 x 7 mm or 40 x 5 mm
A_2	Screen print	35 x 12 mm	D	Barrel print 360°	60 x 35 mm

CHALLENGER Clear MT



2925 2925

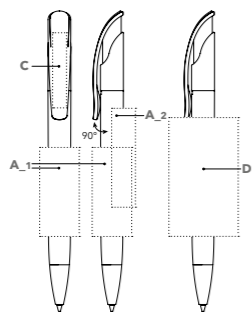

Art. No 2925

Push ball pen
Glossy transparent body and clip surface,
glossy metal tip,
senator® magic flow G2 refill (1.0 mm)
ink colour: blue or black

SERVICES

PMS Service: from 10,000 pieces, see page 112

COLOURS

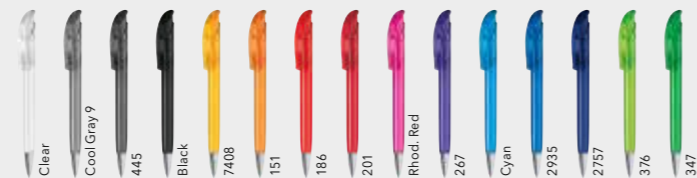

BRANDING / AREA

A_1	Screen print	45 x 20 mm	C	Tampo print	35 x 7 mm or 40 x 5 mm
A_2	Screen print	50 x 12 mm	D	Barrel print 360°	60 x 35 mm

CHALLENGER Frosted



2418 2418

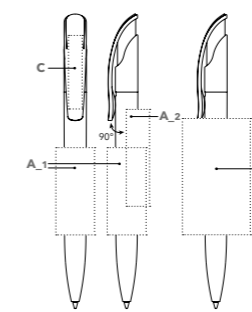

Art. No 2418

Push ball pen
Translucent shine-free body and clip surface,
senator® magic flow G2 refill (1.0 mm)
ink colour: blue or black

SERVICES

5,000 in 5, see page 10
Pen Express, see page 11
PMS Service: from 10,000 pieces, see page 112

COLOURS



BRANDING / AREA

A_1	Screen print	45 x 20 mm	C	Tampo print	35 x 7 mm or 40 x 5 mm
A_2	Screen print	50 x 12 mm	D	Barrel print 360°	60 x 35 mm

CHALLENGER Polished

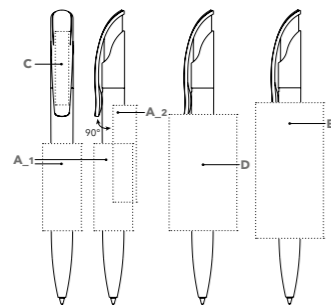
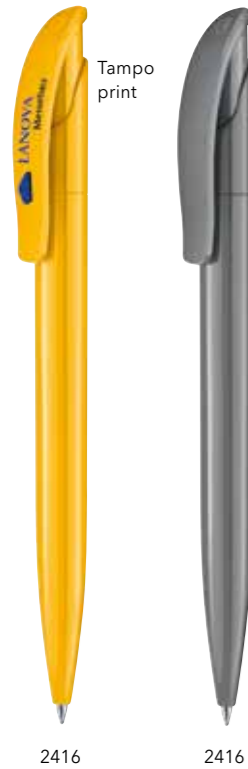

Art. No 2416

Push ball pen
Glossy opaque body and clip surface,
senator® magic flow G2 refill (1.0 mm)
ink colour: blue or black

SERVICES

5,000 in 5, see page 10
PMS Service: from 10,000 pieces, see page 112

COLOURS



BRANDING / AREA

A_1	Screen print	45 x 20 mm	D	Barrel print 360°	60 x 35 mm
A_2	Screen print	50 x 12 mm	E	HD print 360° on white barrel	70 x 35 mm
C	Tampo print	35 x 7 mm or 40 x 5 mm			

2416

2416

CHALLENGER Polished Basic

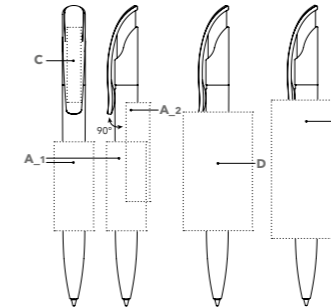
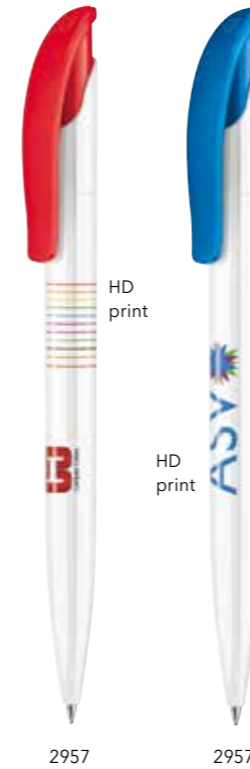

Art. No 2957

Push ball pen
Glossy opaque body and clip surface,
white barrel, coloured clip,
senator® magic flow G2 refill (1.0 mm)
ink colour: blue or black

SERVICES

5,000 in 5, see page 10
PMS Service: from 10,000 pieces, see page 112

COLOURS



BRANDING / AREA

A_1	Screen print	45 x 20 mm	D	Barrel print 360°	60 x 35 mm
A_2	Screen print	50 x 12 mm	E	HD print 360°	70 x 35 mm
C	Tampo print	35 x 7 mm or 40 x 5 mm			

2957

2957

CHALLENGER Polished MT

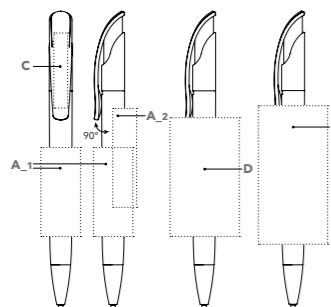

Art. No 2926

Push ball pen
Glossy opaque body and clip surface,
glossy metal tip,
senator® magic flow G2 refill (1.0 mm)
ink colour: blue or black

SERVICES

PMS Service: from 10,000 pieces, see page 112

COLOURS



BRANDING / AREA

A_1	Screen print	45 x 20 mm	D	Barrel print 360°	60 x 35 mm
A_2	Screen print	50 x 12 mm	E	HD print 360° on white barrel	70 x 35 mm
C	Tampo print	35 x 7 mm or 40 x 5 mm			

2926

2926

CHALLENGER Polished Basic SG

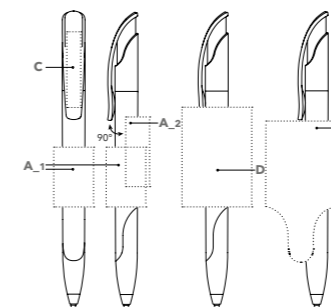

Art. No 2958

Push ball pen
Glossy opaque body and clip surface, white
barrel, coloured clip and soft grip zone,
senator® magic flow G2 refill (1.0 mm)
ink colour: blue or black

SERVICES

PMS Service: from 40,000 pieces, see page 112

COLOURS



BRANDING / AREA

A_1	Screen print	30 x 20 mm or 45 x 10 mm	D	Barrel print 360°	50 x 35 mm
A_2	Screen print	35 x 12 mm	E	HD print 360°	60 x 35 mm
C	Tampo print	35 x 7 mm or 40 x 5 mm			

2958

2958

CHALLENGER

Mix & Match

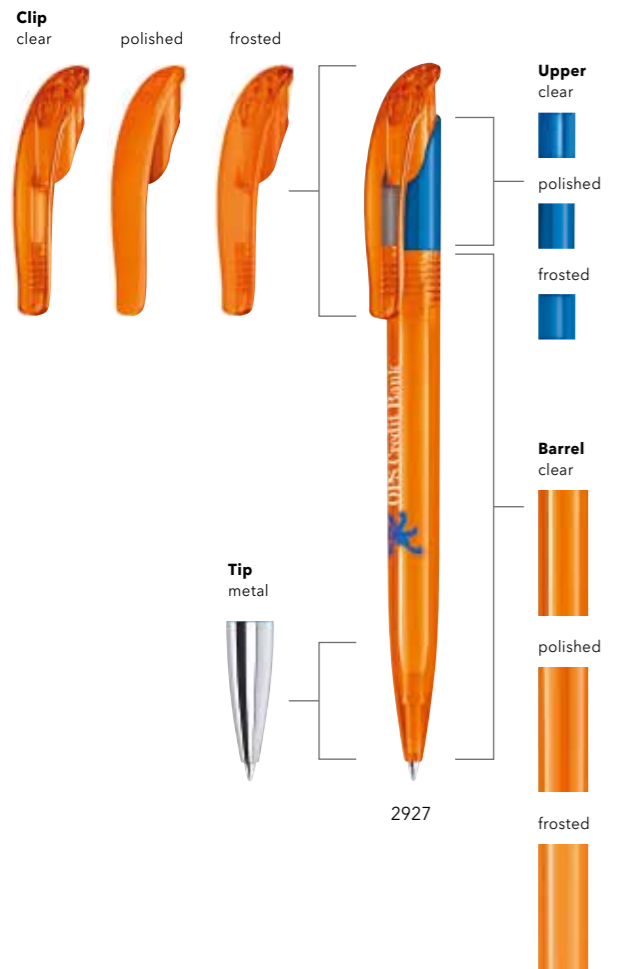

Art. No 2927

Push ball pen
Free combination option of different parts (barrel, upper, clip), surfaces (clear, polished, frosted), accessories and colours, senator® magic flow G2 refill (1.0 mm) ink colour: blue or black

SERVICES

PMS Service: from 10,000 pieces, see page 112

Additional refill option:
Senator magic flow refill 1.4

COLOURS

Clip

clear, polished, frosted

Clear/White	Cool Gray 9	445	Black	7408	151	186	201
Rhod. Red	267	Cyan	2935	2757	376	347	

Upper

clear, polished, frosted

Clear/White	Cool Gray 9	445	Black	7408	151	186	201
Rhod. Red	267	Cyan	2935	2757	376	347	

Barrel

clear, polished, frosted

Clear/White	Cool Gray 9	445	Black	7408	151	186	201
Rhod. Red	267	Cyan	2935	2757	376	347	

Barrel with metal tip

clear

White	Cool Gray 9	445	Black	7408	151	186	201
Rhod. Red	267	Cyan	2935	2757	376	347	

Barrel with metal tip

polished

White	Black
-------	-------

BRANDING / AREA

A_1	Screen print	45 x 20 mm	D	Barrel print 360°	60 x 35 mm
A_2	Screen print	50 x 12 mm	E	HD print 360° on polished white barrel	70 x 35 mm
C	Tampo print	35 x 7 mm or 40 x 5 mm			

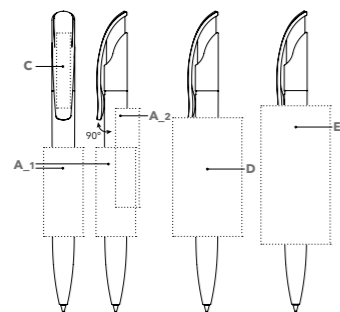

2927

2927

CHALLENGER

Soft Touch

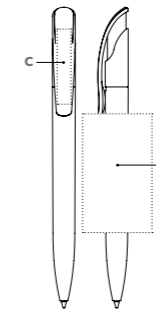

2737

2737

CHALLENGER

Mix & Match (Soft Touch)

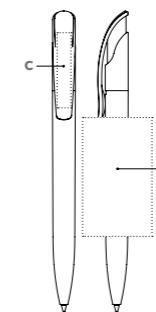

2858

Art. No 2737

Push ball pen
Velvety surface, transparent clip, senator® magic flow G2 refill (1.0 mm) ink colour: blue or black

SERVICES

PMS Service: from 10,000 pieces, see page 112

COLOURS



BRANDING / AREA

C	Tampo print	35 x 7 mm or 40 x 5 mm	D	Barrel print 360°	60 x 35 mm
---	-------------	------------------------	---	-------------------	------------

Art. No 2858

Push ball pen
Velvety surface + free combination options of different parts and colours, senator® magic flow G2 refill (1.0 mm) ink colour: blue or black

SERVICES

PMS Service: from 10,000 pieces, see page 112

Additional refill option:
Senator magic flow refill 1.4

COLOURS

Clip

clear, polished, frosted

Clear	Cool Gray 9	445	Black	7408	151	186	201
Rhod. Red	267	Cyan	2935	2757	376	347	

Barrel/Upper

soft touch

Clear	Cool Gray 9	445	Black	7408	151	186	201
Rhod. Red	267	Cyan	2935	2757	376	347	

BRANDING / AREA

C	Tampo print	35 x 7 mm or 40 x 5 mm	D	Barrel print 360°	60 x 35 mm
---	-------------	------------------------	---	-------------------	------------

NEW HIT Matt Basic

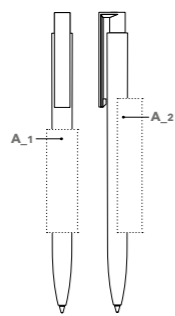
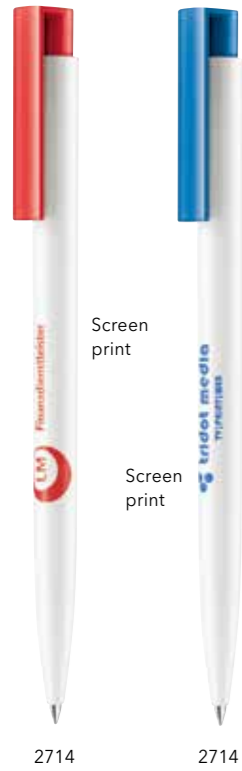

Art. No 2714

Push ball pen
Opaque, shine-free finish surface,
senator® magic flow X20 refill (1.0 mm)
ink colour: blue or black

SERVICES

PMS Service: on request

COLOURS

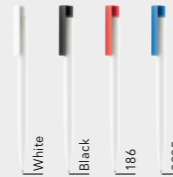

BRANDING / AREA

A_1 Screen print	50 x 15 mm 1 colour	A_2 Screen print	65 x 12 mm 1 colour
-------------------------	------------------------	-------------------------	------------------------

DART Clear

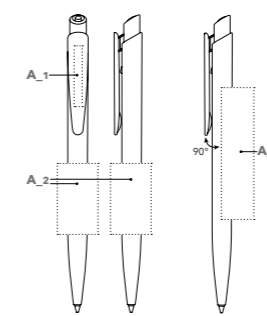
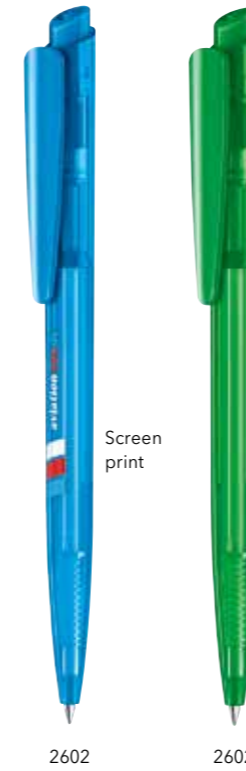

Art. No 2602

Push ball pen
Glossy transparent body surface, glossy
opaque clip pusher,
senator® magic flow X20 refill (1.0 mm)
ink colour: blue or black

SERVICES

5,000 in 5, see page 10
PMS Service: from 10,000 pieces, see page 112

COLOURS



BRANDING / AREA

A_1 Screen print	30 x 4 mm or 25 x 5 mm or 20 x 6 mm	A_2 Screen print	35 x 20 mm
		A_3 Screen print	65 x 12 mm

DART Polished

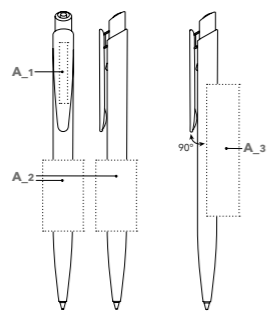

Art. No 2600

Push ball pen
Glossy opaque body and clip surface,
senator® magic flow X20 refill (1.0 mm)
ink colour: blue or black

SERVICES

5,000 in 5, see page 10
Pen Express, see page 11
PMS Service: from 10,000 pieces, see page 112

COLOURS

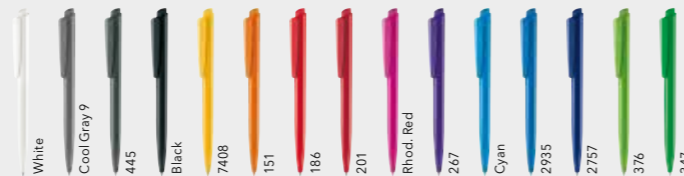

BRANDING / AREA

A_1 Screen print	30 x 4 mm or 25 x 5 mm or 20 x 6 mm	A_2 Screen print	35 x 20 mm
		A_3 Screen print	65 x 12 mm

DART Polished Basic

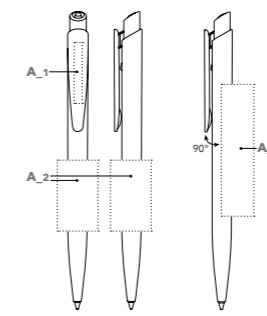

Art. No 2959

Push ball pen
Glossy opaque body and clip surface, white
barrel, coloured clip pusher,
senator® magic flow X20 refill (1.0 mm)
ink colour: blue or black

SERVICES

5,000 in 5, see page 10
Pen Express, see page 11
PMS Service: from 10,000 pieces, see page 112

COLOURS

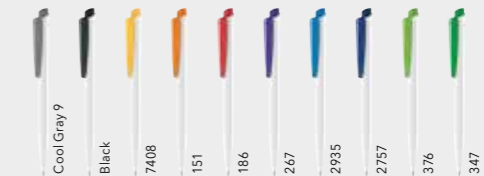

BRANDING / AREA

A_1 Screen print	30 x 4 mm or 25 x 5 mm or 20 x 6 mm	A_2 Screen print	35 x 20 mm
		A_3 Screen print	65 x 12 mm

SUPER HIT Clear



Screen print

2756

2756

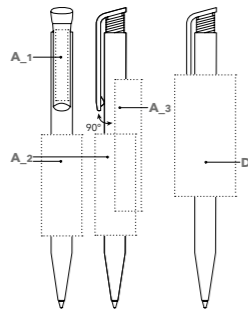

Art. No 2756

Push ball pen
Glossy transparent body and clip surface,
senator® magic flow X20 refill (1.0 mm)
ink colour: blue or black

SERVICES

5,000 in 5, see page 10
PMS Service: from 10,000 pieces, see page 112

COLOURS



BRANDING / AREA

A_1	Screen print	35 x 6 mm	D	Barrel print 360°	60 x 30 mm
A_2	Screen print	50 x 20 mm			
A_3	Screen print	65 x 13 mm			

SUPER HIT Frosted



Screen print

2244

2244

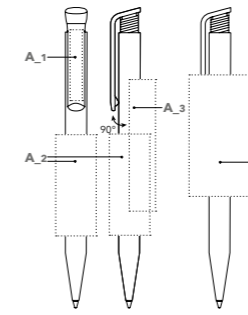

Art. No 2244

Push ball pen
Translucent shine-free body surface,
glossy opaque clip pusher,
senator® magic flow X20 refill
ink colour: blue or black

SERVICES

5,000 in 5, see page 10
Pen Express, see page 11
PMS Service: from 10,000 pieces, see page 112

COLOURS



BRANDING / AREA

A_1	Screen print	35 x 6 mm	D	Barrel print 360°	60 x 30 mm
A_2	Screen print	50 x 20 mm			
A_3	Screen print	65 x 13 mm			

SUPER HIT Clear SG

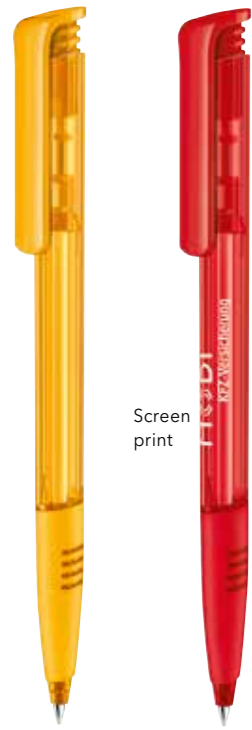

Screen print

2234

2234

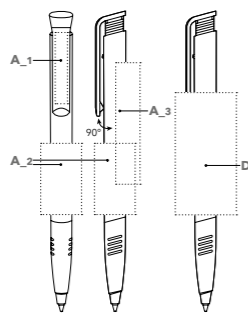

Art. No 2234

Push ball pen
Glossy transparent body and clip surface,
coloured soft grip zone,
senator® magic flow X20 refill (1.0 mm)
ink colour: blue or black

SERVICES

5,000 in 5, see page 10
PMS Service: from 40,000 pieces, see page 112

COLOURS

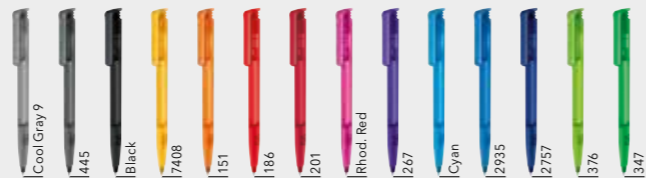

BRANDING / AREA

A_1	Screen print	35 x 6 mm	D	Barrel print 360°	60 x 30 mm
A_2	Screen print	35 x 20 mm			
A_3	Screen print	60 x 12 mm			

SUPER HIT Matt



Screen print

2904

2904

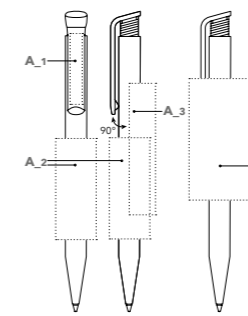

Art. No 2904

Push ball pen
Opaque, shine-free finish body surface,
glossy opaque clip pusher,
senator® magic flow X20 refill (1.0 mm)
ink colour: blue or black

SERVICES

5,000 in 5, see page 10
PMS Service: from 10,000 pieces, see page 112

COLOURS



BRANDING / AREA

A_1	Screen print	35 x 6 mm	D	Barrel print 360°	60 x 30 mm
A_2	Screen print	50 x 20 mm			
A_3	Screen print	65 x 13 mm			

SUPER HIT Polished



2883 2883

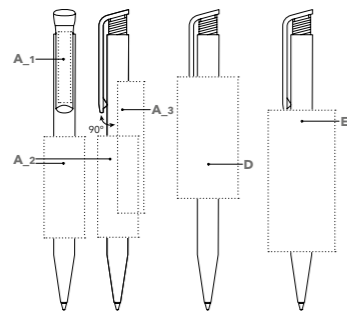

Art. No 2883

Push ball pen
Glossy opaque body and clip surface,
senator® magic flow X20 refill (1.0 mm)
ink colour: blue or black

SERVICES

5,000 in 5, see page 10
Pen Express, see page 11
PMS Service: from 10,000 pieces, see page 112

COLOURS



BRANDING / AREA

A_1	Screen print	35 x 6 mm	D	Barrel print 360°	60 x 30 mm
A_2	Screen print	50 x 20 mm	E	HD print 360° on white barrel	70 x 33 mm
A_3	Screen print	65 x 13 mm			

SUPER HIT Polished Basic

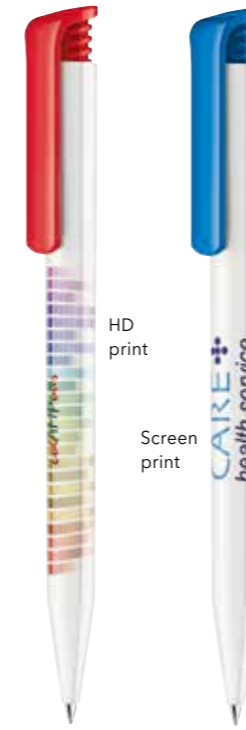

2955 2955

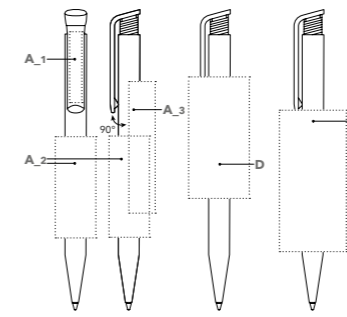
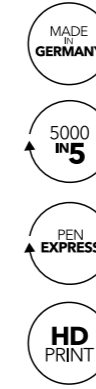

Art. No 2955

Push ball pen
Polished opaque body and clip surface,
white barrel, coloured clip,
senator® magic flow X20 refill (1.0 mm)
ink colour: blue or black

SERVICES

5,000 in 5, see page 10
Pen Express, see page 11
PMS Service: from 10,000 pieces, see page 112

COLOURS

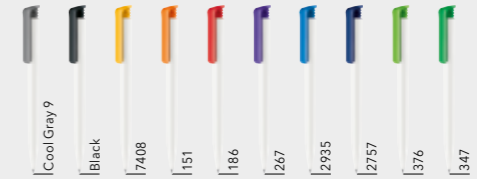

BRANDING / AREA

A_1	Screen print	35 x 6 mm	D	Barrel print 360°	60 x 30 mm
A_2	Screen print	50 x 20 mm	E	HD print 360°	70 x 33 mm
A_3	Screen print	65 x 13 mm			

SUPER HIT Polished Basic SG



2956 2956

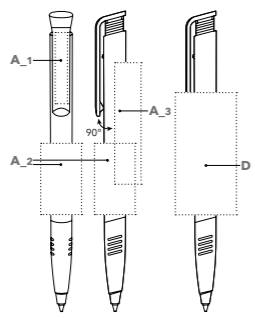

Art. No 2956

Push ball pen
Polished opaque body and clip surface, white
barrel, coloured clip and soft grip zone,
senator® magic flow X20 refill (1.0 mm)
ink colour: blue or black

SERVICES

PMS Service: from 40,000 pieces, see page 112

COLOURS

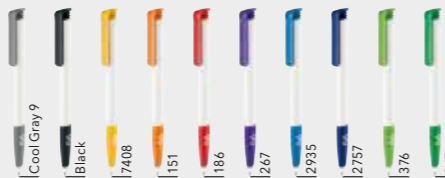

BRANDING / AREA

A_1	Screen print	35 x 6 mm	D	Barrel print 360°	60 x 30 mm
A_2	Screen print	35 x 20 mm			
A_3	Screen print	60 x 12 mm			

SUPER HIT Recycled



2850 2850

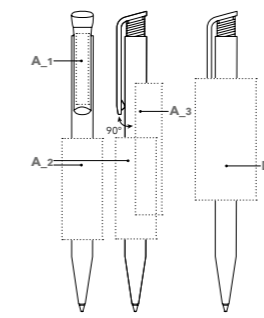

Art. No 2850

Push ball pen
Polished opaque body and clip surface,
black barrel made of 95% recycled material,
coloured clip
senator® magic flow X20 refill (1.0 mm)
ink colour: blue or black

SERVICES

PMS Service: from 10,000 pieces, see page 112

COLOURS



BRANDING / AREA

A_1	Screen print	35 x 6 mm	D	Barrel print 360°	60 x 30 mm
A_2	Screen print	50 x 20 mm			
A_3	Screen print	65 x 13 mm			

SUPER HIT Mix & Match

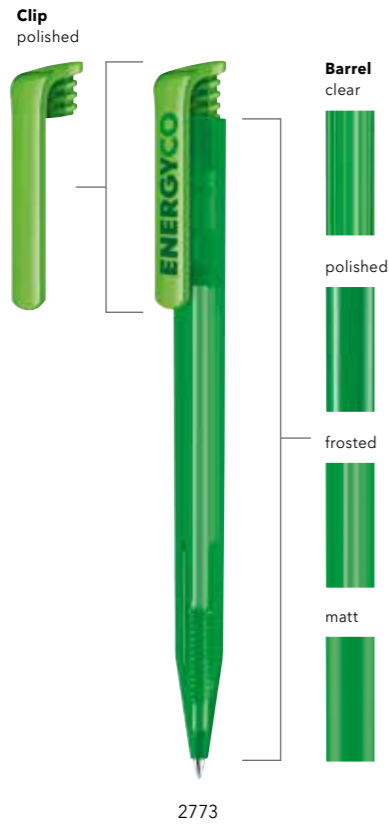

Art. No 2773

Push ball pen
Free combination option of different parts (barrel and clip), surfaces (clear, polished, frosted, matt) and colours, senator® magic flow X20 refill (1.0 mm) ink colour: blue or black

SERVICES

PMS Service: from 10,000 pieces, see page 112

COLOURS

Clip polished

White	Cool Gray 9	445	Black	7408	151	186	201
Rhod. Red	267	Cyan	2935	2757	376	347	

Barrel

clear, polished, frosted, matt

Clear/White	Cool Gray 9	445	Black	7408	151	186	201
Rhod. Red	267	Cyan	2935	2757	376	347	



EXAMPLE

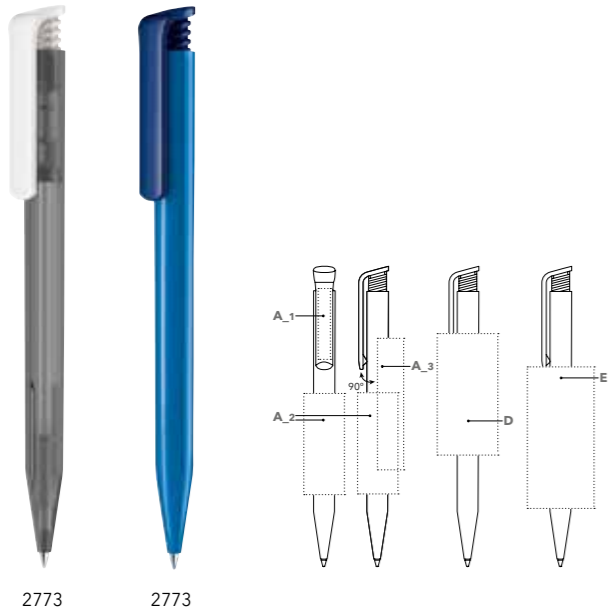

BRANDING / AREA

A_1	Screen print	35 x 6 mm	D	Barrel print 360°	60 x 30 mm
A_2	Screen print	50 x 20 mm	E	HD print 360° on polished white barrel	70 x 33 mm
A_3	Screen print	65 x 13 mm			

POINT Polished

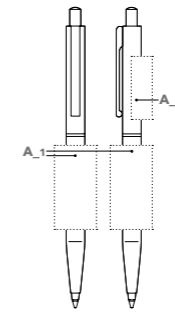

Art. No 3217

Push ball pen
Glossy opaque body surface, metal fittings, push-button with plastic inlay senator® magic flow X20 refill (1.0 mm) ink colour: blue or black

SERVICES

PMS Service: from 30,000 pieces, see page 112

COLOURS



BRANDING / AREA

A_1	Screen print	40 x 20 mm
A_2	Screen print	30 x 10 mm

POINT Metal

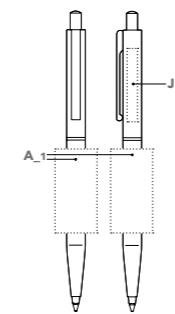

Art. No 2866

Push ball pen
Polished opaque body surface, metal upper part, metal fittings, push-button with plastic inlay senator® metal refill G2 ink colour: blue

SERVICES

PMS Service: from 30,000 pieces, see page 112

COLOURS

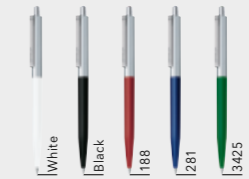

BRANDING / AREA

A_1	Screen print	40 x 20 mm	J	Laser engraving	35 x 5 mm
-----	--------------	------------	---	-----------------	-----------

HATTRIX Clear SG

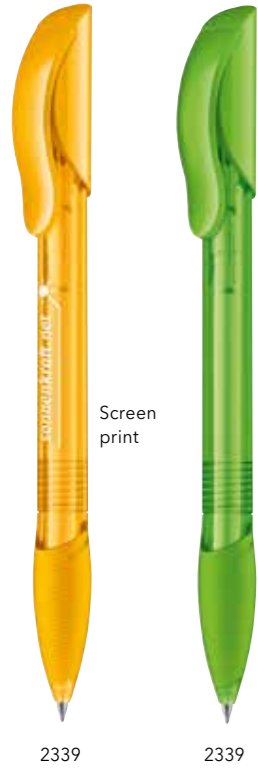

2339

2339

Art. No 2339

Push ball pen
Glossy transparent body surface, upper part and clip polished, coloured soft grip
senator® magic flow G2 refill (1.0 mm)
ink colour: blue or black

SERVICES

PMS Service: from 40,000 pieces, see page 112

COLOURS



BRANDING / AREA

A_1	Screen print	35 x 20 mm	C_1	Tampo print	20 x 7 mm
A_2	Screen print	40 x 13 mm	C_2	Tampo print	10 x 7 mm or 19 x 4 mm 1 colour
			D	Barrel print 360°	75 x 33.9 mm

HATTRIX Polished Basic

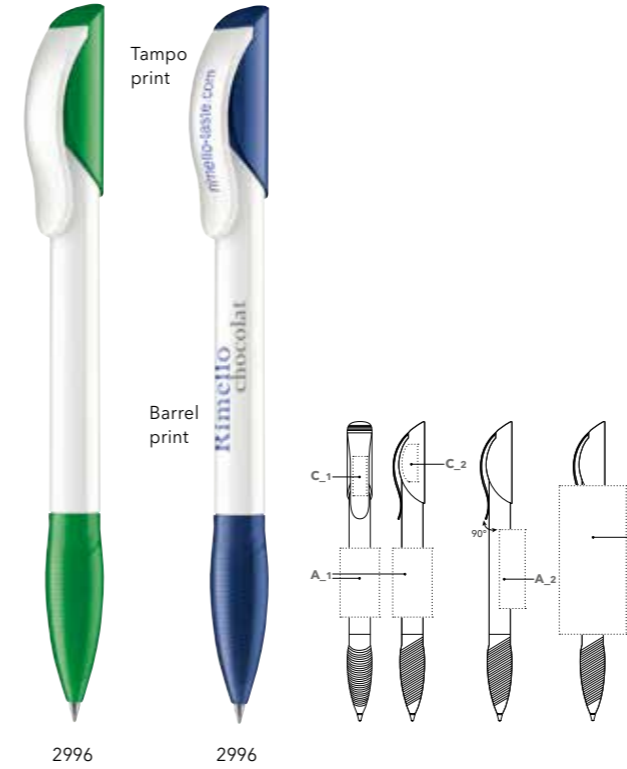

2996

2996

Art. No 2996

Push ball pen
Glossy opaque body and clip surface,
white barrel and clip, coloured upper part,
senator® magic flow X20 refill
ink colour: blue or black

SERVICES

PMS Service: from 10,000 pieces, see page 112

COLOURS



BRANDING / AREA

A_1	Screen print	35 x 20 mm	C_1	Tampo print	20 x 7 mm
A_2	Screen print	40 x 13 mm	C_2	Tampo print	10 x 7 mm or 19 x 4 mm 1 colour
			D	Barrel print 360°	75 x 33.9 mm

HATTRIX Clear SG MC



2419

2419

Art. No 2419

Push ball pen
Glossy transparent body surface, upper part polished, coloured soft grip zone fits with the barrel, metal clip,
senator® magic flow G2 refill (1.0 mm)
ink colour: blue or black

SERVICES

PMS Service: from 40,000 pieces, see page 112

COLOURS



BRANDING / AREA

A_1	Screen print	35 x 20 mm	C	Tampo print	10 x 7 mm or 19 x 4 mm 1 colour
A_2	Screen print	40 x 13 mm			
			D	Barrel print 360°	75 x 33.9 mm

HATTRIX Polished Basic SG

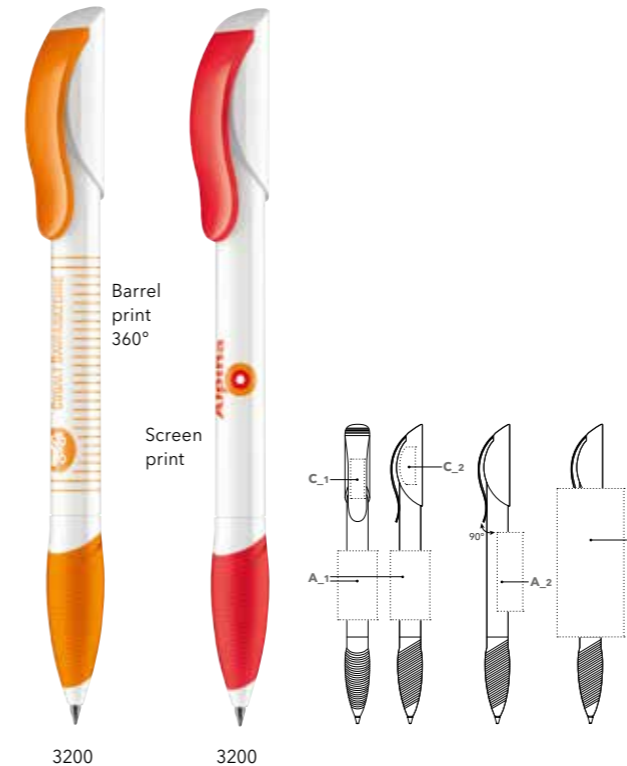

3200

3200

Art. No 3200

Push ball pen
Glossy opaque body and clip surface,
white barrel, coloured clip and soft grip zone,
senator® magic flow X20 refill
ink colour: blue or black

SERVICES

PMS Service: from 40,000 pieces, see page 112

COLOURS



BRANDING / AREA

A_1	Screen print	35 x 20 mm	C_1	Tampo print	20 x 7 mm
A_2	Screen print	40 x 13 mm	C_2	Tampo print	10 x 7 mm or 19 x 4 mm 1 colour
			D	Barrel print 360°	75 x 33.9 mm

HATTRIX

Polished Basic SG MC

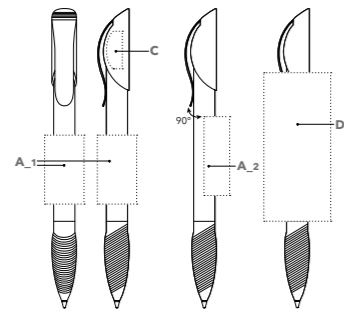

Art. No 3201

Push ball pen
Glossy opaque body and clip surface, white barrel, metal clip and coloured soft grip zone, senator® magic flow G2 refill
ink colour: blue or black

SERVICES

PMS Service: from 40,000 pieces, see page 112

COLOURS

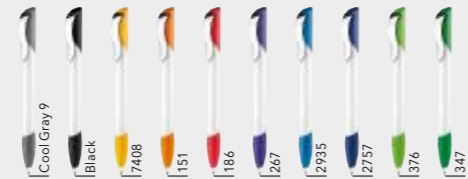

BRANDING / AREA

A_1 Screen print	35 x 20 mm	C Tampo print	10 x 7 mm or 19 x 4 mm
A_2 Screen print	40 x 13 mm	D Barrel print 360°	75 x 33.9 mm

CENTRIX®

Mix & Match

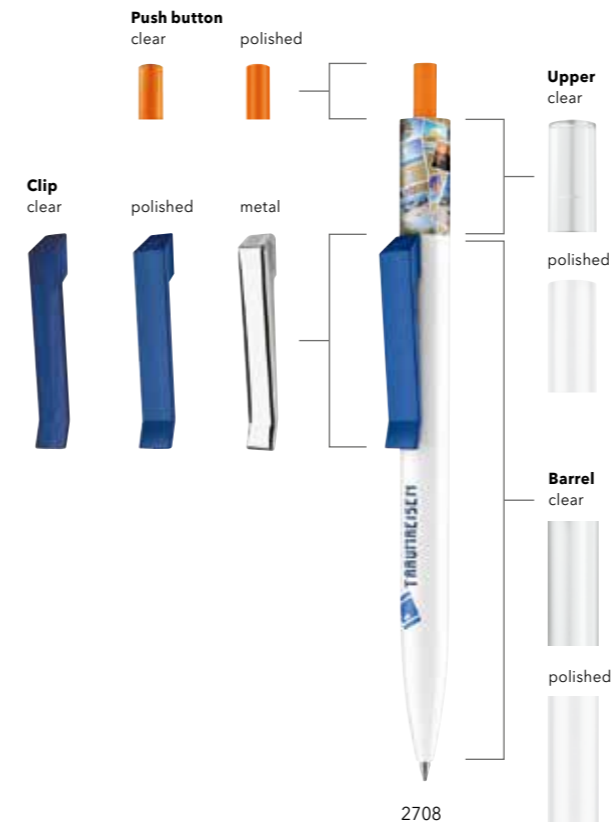

Art. No 2708

Push ball pen
Free combination option of different parts (barrel, upper, push-button and clip), surfaces (polished and clear), accessories (metal clip and metal springs) and colours, senator® magic flow G2 refill (1.0 mm) ink colour: blue or black

SERVICES

PMS Service: from 10,000 pieces, see page 112

Additional refill option:
Senator magic flow refill 1.4

COLOURS

Clip

clear, polished, optional metal clip

Clear/White	Cool Gray 9	445	Black	7408	151	186	201
Rhod. Red	267	Cyan	2935	2757	376	347	

Push button

clear, polished

Clear/White	Cool Gray 9	445	Black	7408	151	186	201
Rhod. Red	267	Cyan	2935	2757	376	347	

Upper

clear, polished

Clear/White	Cool Gray 9	445	Black	7408	151	186	201
Rhod. Red	267	Cyan	2935	2757	376	347	

Barrel

clear, polished

Clear/White	Cool Gray 9	445	Black	7408	151	186	201
Rhod. Red	267	Cyan	2935	2757	376	347	

HATTRIX

Mix & Match

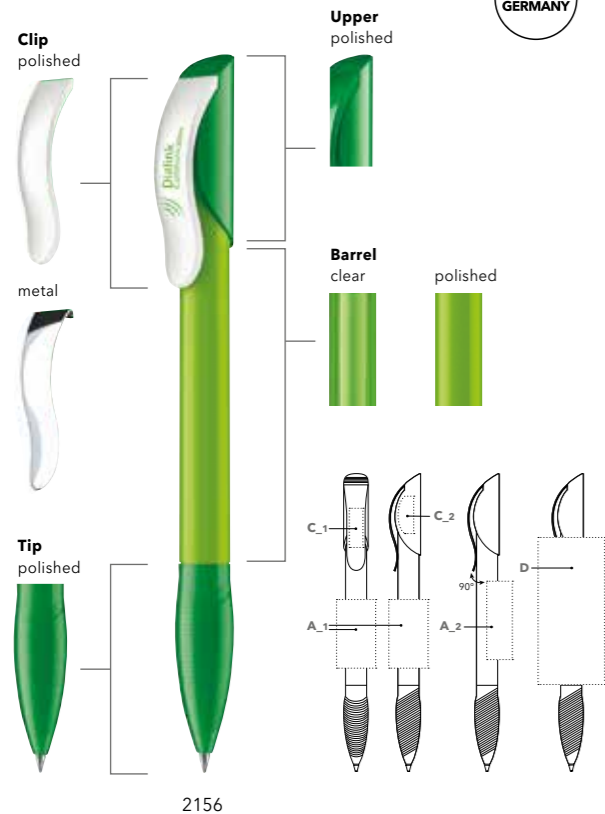

Art. No 2156

Push ball pen
Free combination option of different parts (barrel, tip, upper and clip), surfaces (polished and clear for barrel & tip, polished for clip and upper), accessories (metal clip) and colours, senator® magic flow G2 refill (1.0 mm), ink colour: blue or black

SERVICES

PMS Service: from 10,000 pieces, see page 112

Additional refill option:
Senator magic flow refill 1.4

COLOURS

Clip/Upper/Tip
polished, optional metal clip

White	Cool Gray 9	Black	7408	151	186	267	2935
2757	376	347					

Barrel
clear (not in white), polished

White	Cool Gray 9	Black	7408	151	186	267	2935
2757	376	347					

BRANDING / AREA

A_1 Screen print	35 x 20 mm	C_2 Tampo print	10 x 7 mm or 19 x 4 mm
A_2 Screen print	40 x 13 mm	D Barrel print 360°	75 x 33.9 mm
C_1 Tampo print	20 x 7 mm		



EXAMPLE

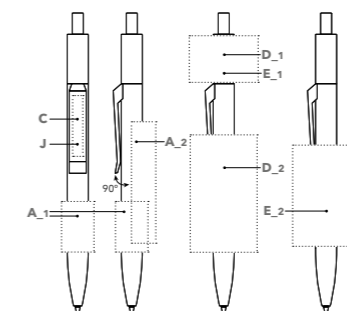

BRANDING / AREA

A_1 Screen print	25 x 16 mm	D_2 Barrel print 360°	58 x 33 mm
A_2 Screen print	60 x 12 mm	E_1 HD print 360° on white barrel	24,5 x 34 mm
C Tampo print	30 x 5 mm	E_2 HD print 360° on white barrel	50 x 33 mm
D_1 Barrel print 360°	24 x 34 mm	J Metal clip: Laser engraving	30 x 5 mm

BIG PEN

Mix & Match

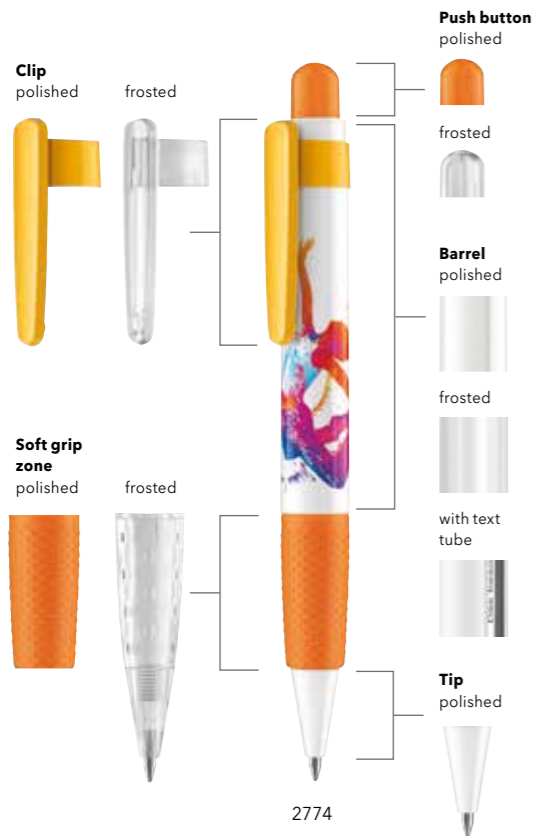

2774



EXAMPLE



2774

2774

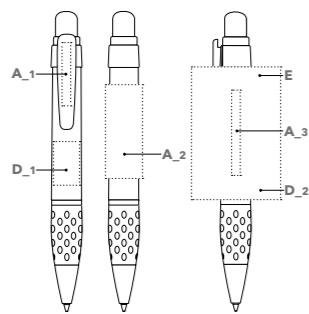

Art. No 2774

Push ball pen
Free combination option of different parts (barrel, tip, push-button and clip), surfaces (frosted (white only except for barrel) or polished), accessories (coloured polished or white frosted soft grip) and colours, X20 jumbo refill, ink colour: blue or black

SERVICES

PMS Service: from 30,000 pieces, see page 112

COLOURS

Push button polished

White	Cool Gray 9	445	Black	7408	151	186	202
Cyan	2935	2757	376	347			

Clip polished

White	Cool Gray 9	445	Black	7408	151	186	202
Cyan	2935	2757	376	347			

Barrel polished, frosted

White	Cool Gray 9	445	Black	7408	151	186	202
Cyan	2935	2757	376	347			

Soft grip zone polished

Cool Gray 9	445	Black	7408	151	186	202	Cyan
2935	2757	376	347				

Tip polished

White	Cool Gray 9	445	Black	7408	151	186	202
Cyan	2935	2757	376	347			

Push button/clip/tip/soft grip zone frosted

White

Barrel with text tube polished

White

BRANDING / AREA

A_1 Screen print	29 x 4 mm	D_1 Barrel print 360°	20 x 12 mm
A_2 Screen print	43 x 17 mm	D_2 Barrel print 360°	61 x 40.9 mm
A_3 Screen print on text tube	6 lines, each 38 x 3 mm 1 colour	E HD print 360° on polished white barrel	61.6 x 41 mm

BIG PEN

Polished Basic

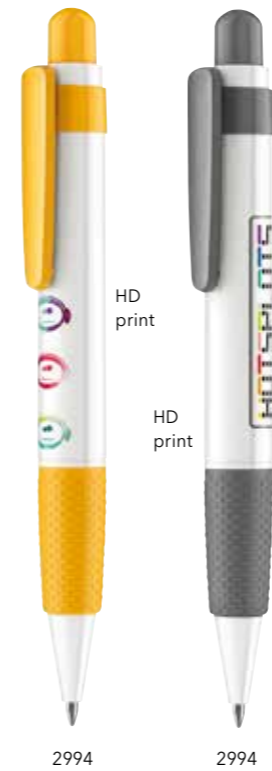

2994

2994

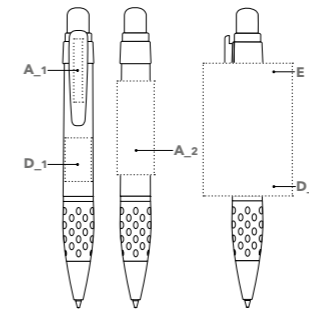

BIG PEN

Frosted



1177

1177

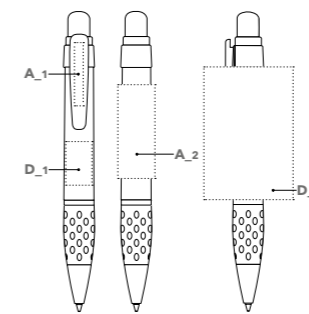

Art. No 2994

Push ball pen
White barrel with glossy opaque body surface, soft grip zone, coloured opaque clip and push clip, X20 jumbo refill, ink colour: blue or black

SERVICES

PMS Service: from 30,000 pieces, see page 112

COLOURS



BRANDING / AREA

A_1 Screen print	29 x 4 mm	D_1 Barrel print 360°	20 x 12 mm
A_2 Screen print	43 x 17 mm	D_2 Barrel print 360°	61 x 40.9 mm
E	HD print 360°		61.6 x 41 mm

Art. No 1177

Push ball pen
Coloured frosted body surface, white frosted clip, tip and push clip, X20 jumbo refill, ink colour: blue or black

SERVICES

PMS Service: from 30,000 pieces, see page 112

COLOURS

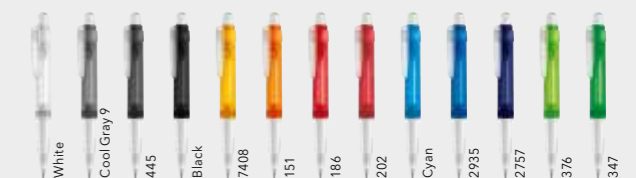

BRANDING / AREA

A_1 Screen print	29 x 4 mm	D_1 Barrel print 360°	20 x 12 mm
A_2 Screen print	43 x 17 mm	D_2 Barrel print 360°	61 x 40.9 mm



NATURE PLUS

MORE RESPECT. MORE NATURE.

A plastic ball pen which genuinely respects the environment? That's the **Nature Plus**. We don't believe you have to compromise on great design to create a genuinely biodegradable pen crafted from renewable raw material. If you want to communicate your environmental awareness down to the last detail, yet also love cheerful colours, Nature Plus is the pen for you. Borne from the harmony of contemporary elegance, reliable functionality and a uniquely sustainable promise, it offers striking promotional spaces and an on-trend design.



NEW SPRING Clear



reddot design award winner 2006



Screen print

2426

2426

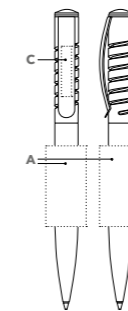

Art. No 2426

Push ball pen
Glossy transparent body and surface, metallised inner push-button, senator® magic flow G2 refill (1.0 mm)
ink colour: blue or black

SERVICES

PMS Service: from 10,000 pieces, see page 112

COLOURS



BRANDING / AREA

A Screen print 40 x 20 mm C Tampo print 25 x 5 mm

NATURE PLUS Matt



Art. No 2796

Push ball pen
Opaque, shine-free finish barrel and clip surface, biodegradable material, senator® magic flow G2 refill (1.0 mm)
ink colour: blue or black

SERVICES

PMS Service: from 20,000 pieces, see page 112

COLOURS

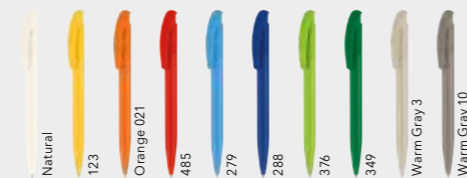

BRANDING / AREA

A_1 Screen print 45 x 20 mm J_1 Laser engraving 26 x 6 mm
A_2 Screen print 50 x 15 mm J_2 Laser engraving 45 x 6 mm
C Tampo print 30 x 5 mm

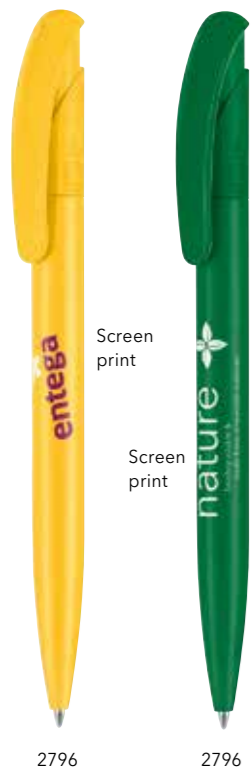

Screen print

Screen print

2796

2796

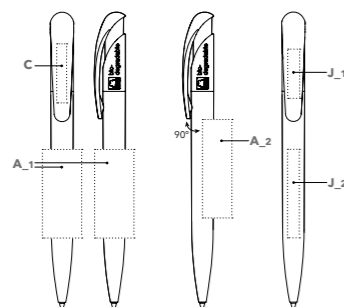

NEW SPRING Clear MC



reddot design award winner 2006



Screen print

2410

2410

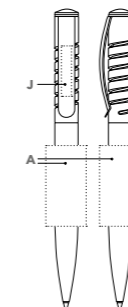

Art. No 2410

Push ball pen
Glossy transparent body surface, metallised inner push-button, metal clip, senator® magic flow G2 refill (1.0 mm)
ink colour: blue or black

SERVICES

PMS Service: from 10,000 pieces, see page 112

COLOURS



BRANDING / AREA

A Screen print 40 x 20 mm J Laser engraving 30 x 6 mm

NEW SPRING Clear MB MC



reddot design award
winner 2006

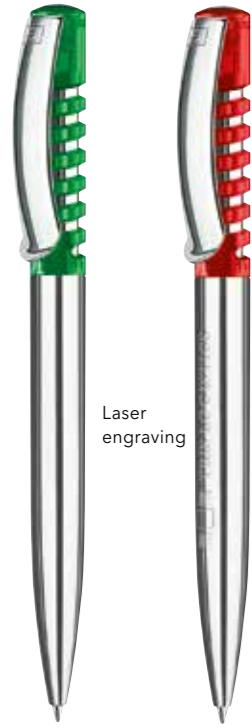

Laser engraving

2561

2561

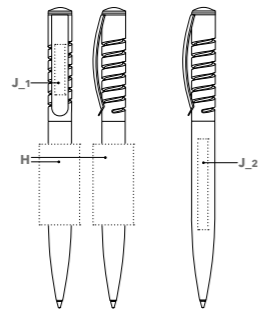

Art. No 2561

Push ball pen
Glossy transparent upper part, metal barrel,
metallised inner push-button, metal clip
senator® magic flow G2 refill (1.0 mm)
ink colour: blue or black

SERVICES

PMS Service: from 10,000 pieces, see page 112

COLOURS



BRANDING / AREA

H	Metal print	40 x 20 mm	J_1	Laser engraving	30 x 6 mm
			J_2	Laser engraving	45 x 5 mm

NEW SPRING Polished MB MC



reddot design award
winner 2006



Laser engraving

Laser engraving

2431

2431

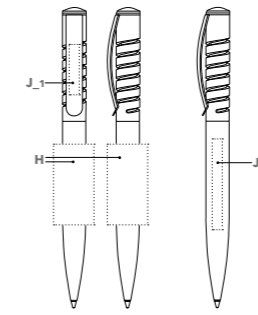

Art. No 2431

Push ball pen
Glossy opaque upper part, metal barrel,
metallised inner push-button, metal clip
senator® magic flow G2 refill (1.0 mm)
ink colour: blue or black

SERVICES

PMS Service: from 10,000 pieces, see page 112

COLOURS



BRANDING / AREA

H	Metal print	40 x 20 mm	J_1	Laser engraving	30 x 6 mm
			J_2	Laser engraving	45 x 5 mm

NEW SPRING Polished MC



reddot design award
winner 2006



HD print

2310

2310

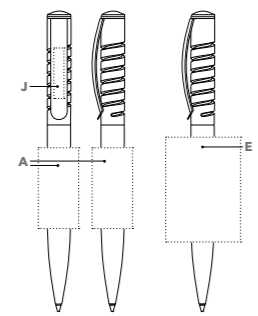

Art. No 2310

Push ball pen
Glossy opaque body surface, metallised
inner push-button, metal clip,
senator® magic flow G2 refill (1.0 mm)
ink colour: blue or black

SERVICES

PMS Service: from 10,000 pieces, see page 112

COLOURS



BRANDING / AREA

A	Screen print	40 x 20 mm	J	Laser engraving	30 x 6 mm
E	HD print 360° on white barrel	51 x 37 mm			

SOFT SPRING Polished

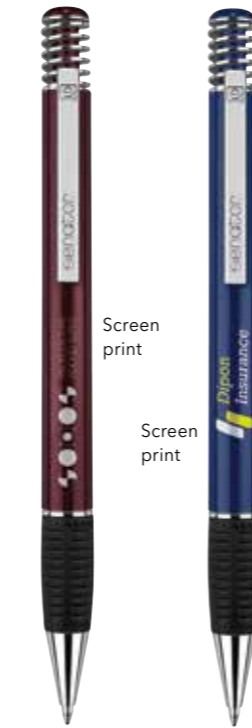

Screen print

Screen print

2067

2067

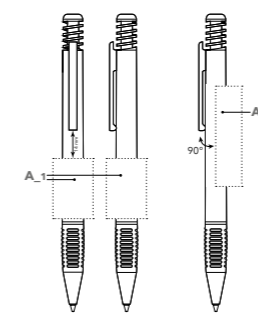

Art. No 2067

Push ball pen
Glossy opaque body surface with metallic
pigments (except for white and black),
metallised tip and spring, black soft grip
zone, metal clip,

senator® magic flow G2 refill (1.0 mm)
ink colour: blue or black

SERVICES

PMS Service: from 25,000 pieces, see page 112

COLOURS

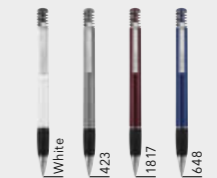

BRANDING / AREA

A_1	Screen print	30 x 20 mm
A_2	Screen print	50 x 13 mm

DUO PEN Polished



2122 2122

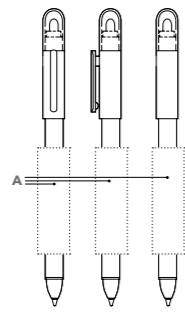

Art. No 2122

Twist mechanism ball pen
Glossy opaque body surface, combination
of ball pen with black ink and highlighter
with yellow ink

SERVICES

PMS Service: from 30,000 pieces, see page 112

COLOURS



BRANDING / AREA

A Screen print 50 x 15 mm
1 colour

MATRIX Polished



2318 2318

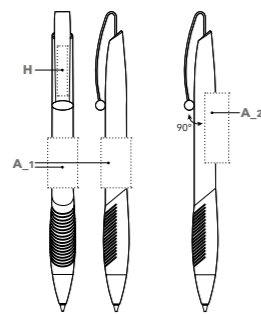

Art. No 2318

Push ball pen
Glossy opaque body surface, black soft grip
zone, matt metal clip,
senator® magic flow G2 refill (1.0 mm)
ink colour: blue or black

SERVICES

PMS Service: from 30,000 pieces, see page 112

COLOURS



BRANDING / AREA

A_1 Screen print 25 x 15 mm H Metal print 25 x 5 mm
A_2 Screen print 35 x 12 mm

MATRIX Clear



2319 2319

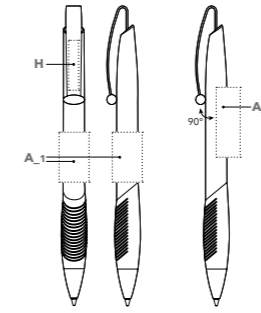

Art. No 2319

Push ball pen
Glossy transparent body surface, black soft
grip zone, matt metal clip,
senator® magic flow G2 refill (1.0 mm)
ink colour: blue or black

SERVICES

PMS Service: from 30,000 pieces, see page 112

COLOURS



BRANDING / AREA

A_1 Screen print 25 x 15 mm H Metal print 25 x 5 mm
A_2 Screen print 35 x 12 mm

MATRIX Polished

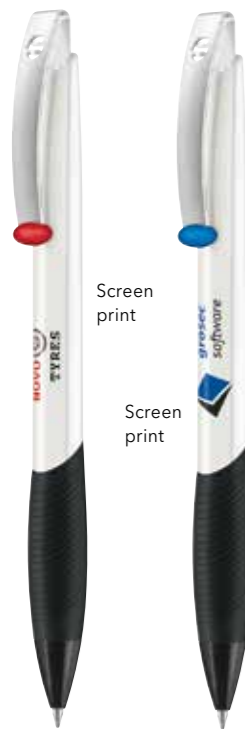

2318 2318

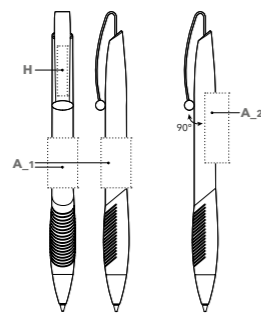

Art. No 2318

Push ball pen
Glossy opaque body surface, black soft grip
zone, matt metal clip,
senator® magic flow G2 refill (1.0 mm)
ink colour: blue or black

SERVICES

PMS Service: from 30,000 pieces, see page 112

COLOURS



BRANDING / AREA

A_1 Screen print 25 x 15 mm H Metal print 25 x 5 mm
A_2 Screen print 35 x 12 mm

MATRIX Clear MT

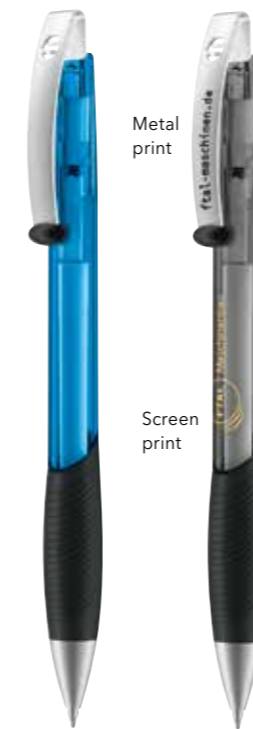

2434 2434

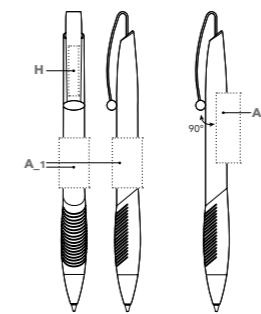

Art. No 2434

Push ball pen
Glossy transparent surface, black soft grip,
matt metal tip and clip,
senator® magic flow G2 refill (1.0 mm)
ink colour: blue or black

SERVICES

PMS Service: from 30,000 pieces, see page 112

COLOURS



BRANDING / AREA

A_1 Screen print 25 x 15 mm H Metal print 25 x 5 mm
A_2 Screen print 35 x 12 mm



NEW

POLAR

**MORE QUALITY.
MORE BENEFIT.**

A high quality metal ballpoint pen "Made in Germany" at a favourable price: **Polar**. This new ball pen combines a modern, linear design with exceptional quality at an unbeatably attractive price. Extend the scope of your brand communication even further.



**POLAR
Ball pen**

NEW

MADE
GERMANY



Laser engraving

Metal print

3260

3260

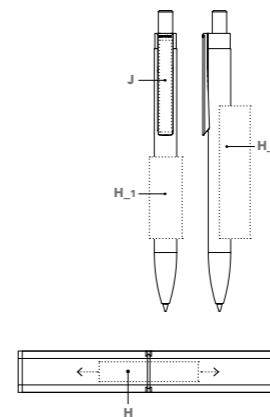

Art. No. 3260

Push ball pen
Barrel: Metal, varnished
Fittings: Metal, glossy chrome
senator® magic flow refill 1.0 mm, G2
Ink colour: Blue

Available from April 2017

CORRESPONDING CASES

ET 169, ET 171, ET 163, ET 160, ET 154,
ET 157, SC 197
see page 76-79

COLOURS

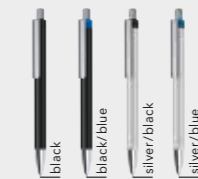

BRANDING / AREA

Writing instrument:
H_1 Metal print 40 x 16 mm
H_2 Metal print 65 x 15 mm
J Laser engraving 45 x 6 mm

Art. No. 6300

Set
Push ball pen 3260 in case ET 169

Available from April 2017

SERVICES

PMS Service (barrel and clip holder):
from 5,000 pieces, see page 112

SET



Case:
H Case print 60 x 12 mm
1 colour

**DEVON
Ball pen**



Metal print

2789

2789

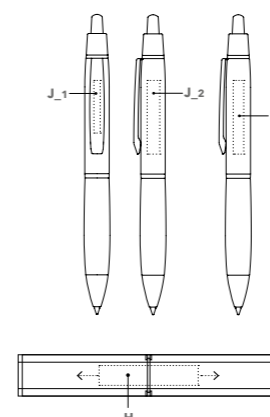

Art. No. 2789

Push ball pen
Barrel: Metal, lacquered, with black soft grip section; Fittings: Metal, glossy chrome
Tip: Metal, lacquered, black
senator® metal refill, G2
Ink colour: Blue

CORRESPONDING CASES

ET 150, ET 157, ET 160, ET 163, ET 169,
ET 181
see page 76-79

COLOURS



BRANDING / AREA

Writing instrument:
H Metal print 35 x 5 mm
1 colour
J_1 Laser engraving 25 x 3 mm
J_2 Laser engraving 35 x 6 mm

Art. No. 6789

Set
Push ball pen 2789 in case ET 169

SERVICES

PMS Service: from 20,000 pieces
see page 112

SET



Case:
H Case print 60 x 12 mm
1 colour

SOFTSTAR STEEL Ball pen + pencil



2040

3004

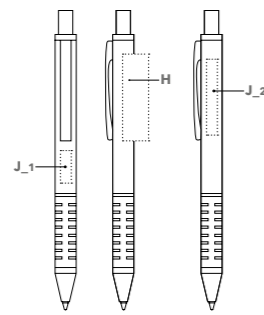

Art. No. 2040

Push ball pen
Barrel: Metal, brushed
Fittings: Metal, glossy chrome
Soft grip zone: Black
senator® metal refill, G2
Ink colour: Blue

CORRESPONDING CASES

ET 150, ET 154, ET 156, ET 157, ET 160,
ET 163, ET 169, ET 181
see page 76-79

COLOURS



BRANDING / AREA

H Metal print 40 x 12 mm

Art. No. 3004

Mechanical pencil
Barrel: Metal, brushed
Fittings: Metal, glossy chrome
Soft grip zone: Black
0.5 mm Hi-Polymer pencil lead

SERVICES

PMS Service: from 10,000 pieces
see page 112

J_1 Laser engraving 15 x 5 mm

J_2 Laser engraving 40 x 5 mm

SOFTSTAR ALU Ball pen + pencil



2511

3111

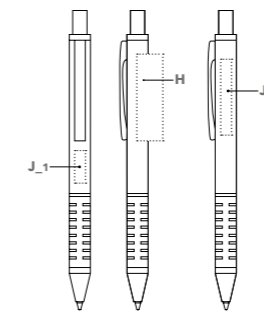

Art. No. 2511

Push ball pen
Barrel: Metal, lacquered
Fittings: Metal, glossy chrome
Soft grip zone: Black
senator® metal refill, G2
Ink colour: Blue

CORRESPONDING CASES

ET 150, ET 154, ET 156, ET 157, ET 160,
ET 163, ET 169, ET 171, ET 181
see page 76-79

COLOURS 2511



BRANDING / AREA

H Metal print 40 x 12 mm

Art. No. 3111

Mechanical pencil
Barrel: Metal, lacquered
Fittings: Metal, glossy chrome
Soft grip zone: Black
0.5 mm Hi-Polymer pencil lead

SERVICES

PMS Service: from 10,000 pieces
see page 112

COLOURS 3111



J_1 Laser engraving 15 x 5 mm

J_2 Laser engraving 40 x 5 mm

SOFTSTAR STEEL Set



6341

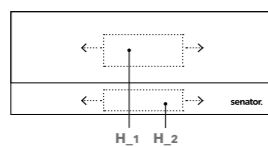

Art. No. 6341

Set
Push ball pen 2040 + mechanical pencil 3004
in case ET 156, black

SERVICES

PMS Service: from 10,000 pieces
see page 112

COLOURS



BRANDING / AREA

Pens:
see art. 2040, 3004

Case:
H_1 Case print 50 x 20 mm
1 colour
H_2 Case print 50 x 15 mm
1 colour

SOFTSTAR ALU Set



6342

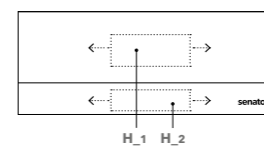

Art. No. 6342

Set
Push ball pen 2511 + mechanical pencil 3111
in black case ET 156

SERVICES

PMS Service: from 10,000 pieces
see page 112

COLOURS



BRANDING / AREA

Pens:
see art. 2511, 3111

Case:
H_1 Case print 50 x 20 mm
1 colour
H_2 Case print 50 x 15 mm
1 colour

DELGADO CLASSIC Ball pen + rollerball



Art. No. 2240

Push ball pen
Barrel: Metal, lacquered
Fittings: Metal, gilt
senator® metal refill, G2
Ink colour: Blue

CORRESPONDING CASES

ET 150, ET 154, ET 156, ET 157, ET 160,
ET 163, ET 169, ET 171, ET 181
see page 76-79

COLOURS



BRANDING / AREA

H_1 Metal print 35 x 5 mm
1 colour
H_2 Metal print 35 x 12 mm
1 colour

Art. No. 1030

Rollerball
Barrel: Metal, lacquered
Fittings: Metal, gilt
Plastic safety rollerball refill
Ink colour: Blue

SERVICES

PMS Service: from 10,000 pieces
see page 112

J_1 Laser engraving 35 x 5 mm
J_2 Laser engraving 35 x 5 mm

DELGADO CLASSIC STEEL Ball pen + rollerball



Art. No. 2239

Push ball pen
Barrel: Metal, stainless steel finish
Fittings: Metal, gilt
senator® metal refill, G2
Ink colour: Blue

CORRESPONDING CASES

ET 150, ET 154, ET 156, ET 157, ET 160,
ET 163, ET 169, ET 171, ET 181
see page 76-79

COLOURS



BRANDING / AREA

H_1 Metal print 35 x 5 mm
1 colour
H_2 Metal print 35 x 12 mm
1 colour

Art. No. 1029

Rollerball
Barrel: Metal, stainless steel finish
Fittings: Metal, gilt
Plastic safety rollerball refill
Ink colour: Blue

SERVICES

PMS Service: from 10,000 pieces
see page 112

J_1 Laser engraving 35 x 5 mm
J_2 Laser engraving 35 x 5 mm

DELGADO CLASSIC Set

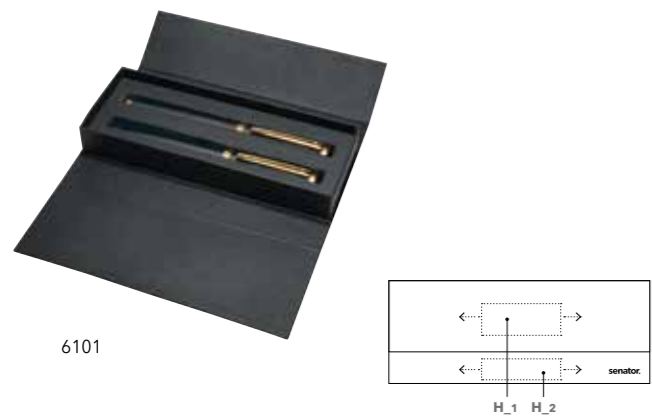

Art. No. 6101

Set
Push ball pen 2240 + rollerball 1030
in black case ET 156

SERVICES

PMS Service: from 10,000 pieces
see page 112

COLOURS



BRANDING / AREA

Pens:
see art. 1030, 2240

Case:
H_1 Case print 50 x 20 mm
1 colour
H_2 Case print 50 x 15 mm
1 colour

DELGADO CLASSIC STEEL Set



Art. No. 6100

Set
Push ball pen 2239 + rollerball 1029
in black case ET 156

SERVICES

PMS Service: from 10,000 pieces
see page 112

COLOURS



BRANDING / AREA

Pens:
see art. 1029, 2239

Case:
H_1 Case print 50 x 20 mm
1 colour
H_2 Case print 50 x 15 mm
1 colour

DELGADO METALLIC Ball pen + rollerball

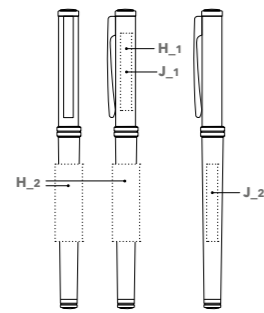

2241 1031

Art. No. 2241

Push ball pen
Barrel: Metal, lacquered
Fittings: Metal, glossy chrome
senator® metal refill G2
Ink colour: Blue

CORRESPONDING CASES

ET 150, ET 154, ET 156, ET 157, ET 160,
ET 163, ET 169, ET 171, ET 181
see page 76-79

COLOURS



BRANDING / AREA

H_1 Metal print 35 x 5 mm
1 colour
H_2 Metal print 35 x 12 mm
1 colour

Art. No. 1031

Rollerball
Barrel: Metal, lacquered
Fittings: Metal, glossy chrome
Plastic safety rollerball refill
Ink colour: Blue

SERVICES

PMS Service: from 10,000 pieces
see page 112

J_1 Laser engraving 35 x 5 mm
J_2 Laser engraving 35 x 5 mm

DELGADO STEEL Ball pen + rollerball

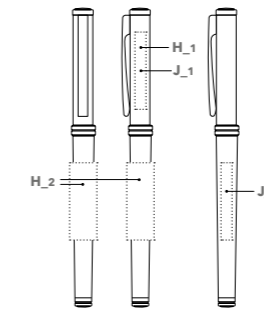

2242 1039

Art. No. 2242

Push ball pen
Barrel: Metal, stainless steel finish
Fittings: Metal glossy chrome
senator® metal refill, G2
Ink colour: Blue

CORRESPONDING CASES

ET 150, ET 154, ET 156, ET 157, ET 160,
ET 163, ET 169, ET 171, ET 181
see page 76-79

COLOURS



BRANDING / AREA

H_1 Metal print 35 x 5 mm
1 colour
H_2 Metal print 35 x 12 mm
1 colour

Art. No. 1039

Rollerball
Barrel: Metal, stainless steel finish
Fittings: Metal, glossy chrome
Plastic safety rollerball refill
Ink colour: Blue

SERVICES

PMS Service: from 10,000 pieces
see page 112

J_1 Laser engraving 35 x 5 mm
J_2 Laser engraving 35 x 5 mm

DELGADO METALLIC Set



6102

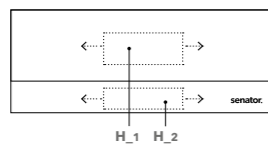

Art. No. 6102

Set
Push ball pen 2241 + rollerball 1031
in black case ET 156

SERVICES

PMS Service: from 10,000 pieces
see page 112

COLOURS



BRANDING / AREA

Pens:
see art. 1031, 2241

Case:
H_1 Case print 50 x 20 mm
1 colour
H_2 Case print 50 x 15 mm
1 colour

DELGADO STEEL Set



6114

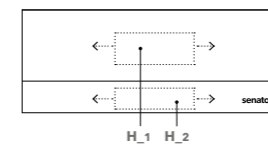

Art. No. 6114

Set
Push ball pen 2242 + rollerball 1039
in black case ET 156

SERVICES

PMS Service: from 10,000 pieces
see page 112

COLOURS



BRANDING / AREA

Pens:
see art. 1039, 2242

Case:
H_1 Case print 50 x 20 mm
1 colour
H_2 Case print 50 x 15 mm
1 colour

NAUTIC Ball pen



Laser engraving

2215

2215

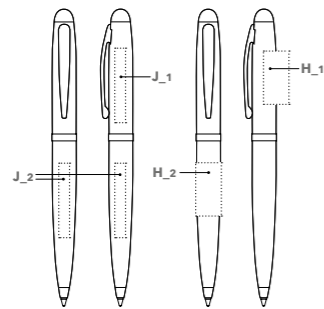

Art. No. 2215

Twist ball pen
Barrel and fittings: Metal, glossy chrome
Cap: Metal, soft lacquer
senator® metal refill, G2
Ink colour: Blue

CORRESPONDING CASES

ET 150, ET 154, ET 156, ET 157, ET 160,
ET 163, ET 169, ET 171, ET 181, SC 197
see page 76-79

COLOURS



BRANDING / AREA

H_1 Metal print 25 x 12 mm
1 colour
H_2 Metal print 25 x 12 mm
1 colour

SERVICES

PMS Service: from 5,000 pieces
see page 112

J_1 Laser engraving 35 x 5 mm

J_2 Laser engraving 35 x 5 mm

NAUTIC Ball pen/Touch Pad Pen



Laser engraving

Laser engraving

2754

2754

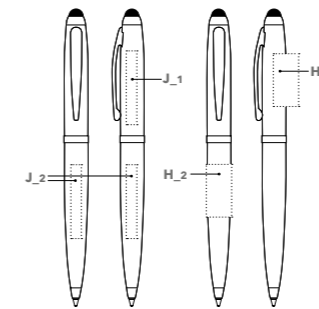

Art. No. 2754

Twist ball pen with touch pad function
Barrel and fittings: Metal, glossy chrome
Cap: Metal, soft lacquer
senator® metal refill, G2
Ink colour: Blue

CORRESPONDING CASES

ET 150, ET 154, ET 156, ET 157, ET 160,
ET 163, ET 169, ET 171, ET 181, SC 197
see page 76-79

COLOURS



BRANDING / AREA

H_1 Metal print 25 x 12 mm
1 colour
H_2 Metal print 25 x 12 mm
1 colour

SERVICES

PMS Service: from 5,000 pieces
see page 112

J_1 Laser engraving 35 x 5 mm

J_2 Laser engraving 35 x 5 mm

NAUTIC Rollerball

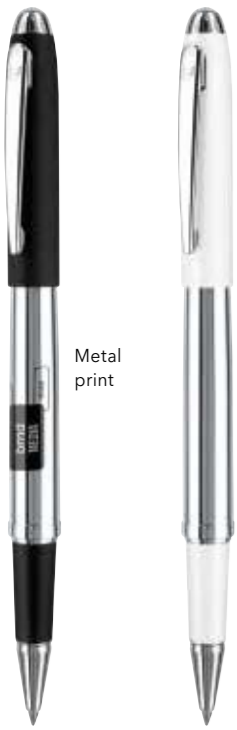

Metal print

1092

1092

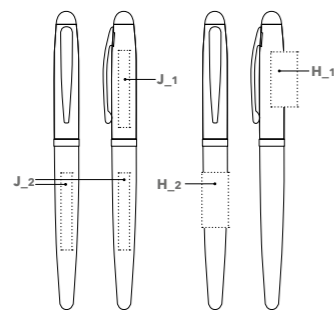

Art. No. 1092

Rollerball
Barrel and fittings: Metal, glossy chrome
Cap and grip zone: Metal, soft lacquer
Metal safety rollerball refill
Ink colour: Blue

CORRESPONDING CASES

ET 150, ET 154, ET 156, ET 157, ET 160,
ET 163, ET 169, ET 171, ET 181, SC 197
see page 76-79

COLOURS



BRANDING / AREA

H_1 Metal print 25 x 12 mm
1 colour
H_2 Metal print 25 x 12 mm
1 colour

SERVICES

PMS Service: from 5,000 pieces
see page 112

J_1 Laser engraving 35 x 5 mm

J_2 Laser engraving 35 x 5 mm

NAUTIC Set



6297

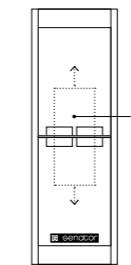

Art. No. 6297

Set
Touch Pad Pen 2754 + rollerball 1092
in case ET 171

SERVICES

PMS Service: from 5,000 pieces
see page 112

COLOURS



BRANDING / AREA

Pens:
see art. 1092, 2215, 2754

Case:
H Case print 60 x 25 mm
1 colour

VISIR

Ball pen + rollerball



Metal print

2253

1056

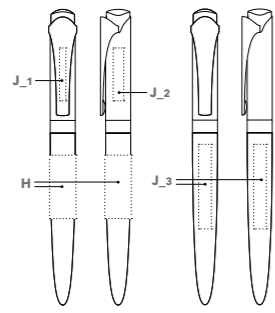

Art. No. 2253

Twist ball pen
Barrel: Metal, glossy lacquered
Fittings: Metal, glossy chrome
senator® metal refill, G2
Ink colour: Blue

CORRESPONDING CASES

ET 150, ET 154, ET 156, ET 157, ET 160,
ET 163, ET 169, ET 171, ET 181
see page 76-79

COLOURS



BRANDING / AREA

H Metal print 30 x 12 mm
1 colour

Art. No. 1056

Rollerball
Barrel: Metal, glossy lacquered
Fittings and cap: Metal, glossy chrome
Metal safety rollerball refill
Ink colour: Blue

SERVICES

PMS Service: from 10,000 pieces
see page 112

J_1 Laser engraving 25 x 3 mm
J_2 Laser engraving 25 x 5 mm
J_3 Laser engraving 40 x 6 mm

VISIR

Set



6298

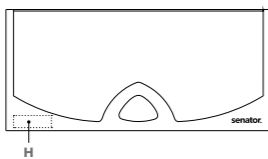

Art. No. 6298

Set
Twist ball pen 2253 + rollerball 1056
in case ET 163

SERVICES

PMS Service: from 10,000 pieces
see page 112

COLOURS



BRANDING / AREA

Pens:
see art. 1056, 2253

Case:
H Case print 25 x 8 mm
1 colour

SIGNER LINER®

Ball pen

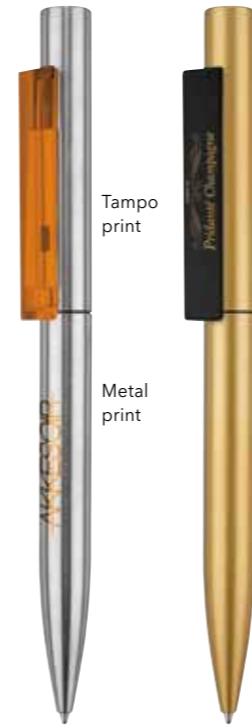

2709

2709

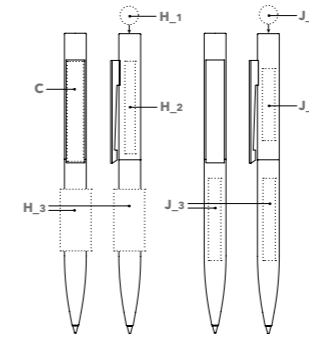

reddot design award
winner 2013



SIGNER LINER®

Set



6299

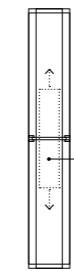

reddot design award
winner 2013



Art. No. 2709

Twist ball pen
Barrel: Stainless steel, sandblasted or
lacquered;

Clip: Plastic; clear or polished
senator® metal refill, G2
Ink colour: Blue

CORRESPONDING CASES

ET 150, ET 154, ET 156, ET 160, ET 163,
ET 169, ET 171, ET 181
see page 76-79

SERVICES

PMS Service (clip): from 2,000 pieces
see page 112

COLOURS

Barrel Metal, sandblasted	steel								
Barrel Metal, lacquered	copper	gun metal	gold						
Clip clear	clear	414	405	418	151	186	286	347	
Clip polished	white	yellow	151	485	188	magenta	288	349	black

BRANDING / AREA

C Tampon print 47 x 7 mm
H_1 Steel: Ø 9 mm
Metal print 1 colour
H_2 Metal print 45 x 5 mm
1 colour
H_3 Metal print 30 x 15 mm
1 colour

J_1 Laser engraving Ø 9 mm
J_2 Laser engraving 35 x 6 mm
J_3 Laser engraving 40 x 6 mm

Art. No. 6299

Set
Twist ball pen 2709 in case ET 169

SERVICES

PMS Service (clip): from 2,000 pieces
see page 112

COLOURS

Barrel Metal, sandblasted	steel								
Barrel Metal, lacquered	copper	gun metal	gold						
Clip clear	clear	414	405	418	151	186	286	347	
Clip polished	white	yellow	151	485	188	magenta	288	349	black

BRANDING / AREA

Pens:
see art. 2709

Case:
H Case print 60 x 12 mm
1 colour

IMAGE® CHROME Ball pen



Metal print

2158

2158

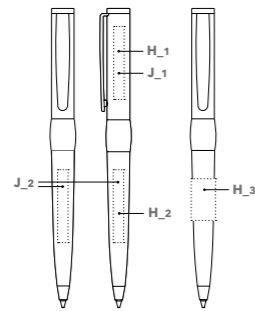

Art. No. 2158

Twist ball pen
Barrel: Metal, soft varnish
Fittings: Metal, matt chrome
senator® metal refill, G2
Ink colour: Blue

CORRESPONDING CASES

ET 150, ET 154, ET 156, ET 157, ET 160,
ET 163, ET 169, ET 171, ET 181, SC 197
see page 76-79

COLOURS



BRANDING / AREA

H_1 Metal print 35 x 5 mm
1 colour
H_2 Metal print 35 x 5 mm
1 colour
H_3 Metal print 20 x 12 mm
1 colour

SERVICES

PMS Service: from 5,000 pieces
see page 112

J_1 Laser engraving 35 x 5 mm
J_2 Laser engraving 35 x 5 mm

IMAGE® CHROME Fountain pen



Metal print

0075

0075

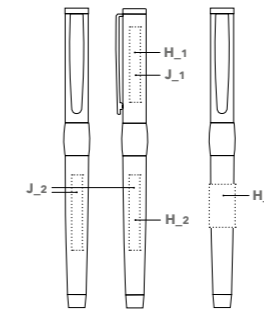

Art. No. 0075

Fountain pen
Barrel: Metal, soft varnish
Fittings: Metal, matt chrome
Iridium-tipped stainless steel nib, M
Standard ink cartridge
Ink colour: Royal blue

CORRESPONDING CASES

ET 150, ET 154, ET 156, ET 157, ET 160,
ET 163, ET 169, ET 171, ET 181, SC 197
see page 76-79

COLOURS



BRANDING / AREA

H_1 Metal print 35 x 5 mm
1 colour
H_2 Metal print 35 x 5 mm
1 colour
H_3 Metal print 20 x 12 mm
1 colour

SERVICES

PMS Service: from 5,000 pieces
see page 112

J_1 Laser engraving 35 x 5 mm
J_2 Laser engraving 35 x 5 mm

IMAGE® CHROME Rollerball



Laser engraving

1036

1036

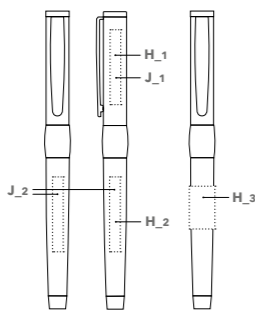

Art. No. 1036

Rollerball
Barrel: Metal, soft varnish
Fittings: Metal, matt chrome
Metal safety rollerball refill
Ink colour: Blue

CORRESPONDING CASES

ET 150, ET 154, ET 156, ET 157, ET 160,
ET 163, ET 169, ET 171, ET 181, SC 197
see page 76-79

COLOURS



BRANDING / AREA

H_1 Metal print 35 x 5 mm
1 colour
H_2 Metal print 35 x 5 mm
1 colour
H_3 Metal print 20 x 12 mm
1 colour

SERVICES

PMS Service: from 5,000 pieces
see page 112

J_1 Laser engraving 35 x 5 mm
J_2 Laser engraving 35 x 5 mm

IMAGE® CHROME Sets



6237 + 6238

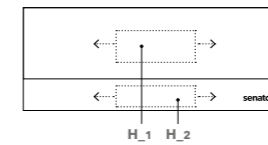

6089 + 6117

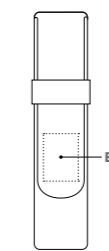

Art. No. 6237

Set
Twist ball pen 2158 + fountain pen 0075
in black case ET 156

BRANDING / AREA

Pens:
see art. 0075, 1036, 2158

Art. No. 6238

Set
Twist ball pen 2158 + rollerball 1036
in black case ET 156

Case:
H_1 Case print 50 x 20 mm, 1 c
H_2 Case print 50 x 15 mm, 1 c

Art. No. 6089

Set
Twist ball pen 2158 + rollerball 1036
in presentation box SC 197 with leather
wallet ET 150

BRANDING / AREA

Pens:
see art. 0075, 1036, 2158

Art. No. 6117

Set
Twist ball pen 2158 + fountain pen 0075
in presentation box SC 197 with leather
wallet ET 150

Case:
EB Embossing 22 x 30 mm

IMAGE® BLACK LINE Ball pen



Laser engraving
Laser engraving

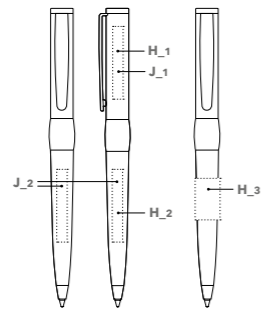

2636 2636

Art. No. 2636

Twist ball pen
Barrel: Metal, soft varnish
Fittings: Metal, gun metal
senator® metal refill, G2
Ink colour: Blue

CORRESPONDING CASES

ET 150, ET 154, ET 156, ET 157, ET 160,
ET 163, ET 169, ET 171, ET 181, SC 197
see page 76-79

COLOURS



BRANDING / AREA

H_1	Metal print	35 x 5 mm
		1 colour
H_2	Metal print	35 x 5 mm
		1 colour
H_3	Metal print	20 x 12 mm
		1 colour

SERVICES

PMS Service: from 5,000 pieces
see page 112

J_1	Laser engraving	35 x 5 mm
J_2	Laser engraving	35 x 5 mm

IMAGE® BLACK LINE Fountain pen



Laser engraving

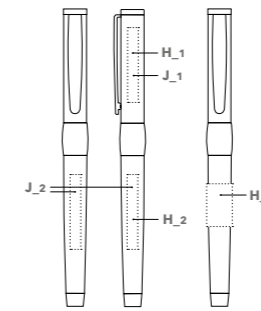

0104 0104

Art. No. 0104

Fountain pen
Barrel: Metal, soft varnish
Fittings: Metal gun metal
Iridium-tipped stainless steel nib, M
Standard ink cartridge
Ink colour: Royal blue

CORRESPONDING CASES

ET 150, ET 154, ET 156, ET 157, ET 160,
ET 163, ET 169, ET 171, ET 181, SC 197
see page 76-79

COLOURS



BRANDING / AREA

H_1	Metal print	35 x 5 mm
		1 colour
H_2	Metal print	35 x 5 mm
		1 colour
H_3	Metal print	20 x 12 mm
		1 colour

SERVICES

PMS Service: from 5,000 pieces
see page 112

J_1	Laser engraving	35 x 5 mm
J_2	Laser engraving	35 x 5 mm

IMAGE® BLACK LINE Rollerball



Metal print

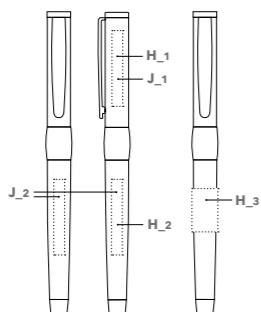

1119 1119

Art. No. 1119

Rollerball
Barrel: Metal, soft varnish
Fittings: Metal, gun metal
Metal safety rollerball refill
Ink colour: Blue

CORRESPONDING CASES

ET 150, ET 154, ET 156, ET 157, ET 160,
ET 163, ET 169, ET 171, ET 181, SC 197
see page 76-79

COLOURS



BRANDING / AREA

H_1	Metal print	35 x 5 mm
		1 colour
H_2	Metal print	35 x 5 mm
		1 colour
H_3	Metal print	20 x 12 mm
		1 colour

SERVICES

PMS Service: from 5,000 pieces
see page 112

J_1	Laser engraving	35 x 5 mm
J_2	Laser engraving	35 x 5 mm

IMAGE® BLACK LINE Sets



6205 + 6206

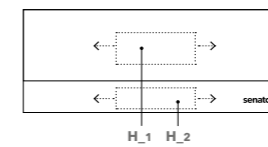

6151 + 6179

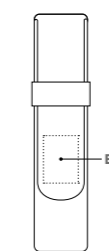

Art. No. 6205

Set
Twist ball pen 2636 + fountain pen 0104
in black case ET 156

BRANDING / AREA

Pens:
see art. 0104, 1119, 2636

Art. No. 6206

Set
Twist ball pen 2636 + rollerball 1119
in black case ET 156

Case:		
H_1	Case print	50 x 20 mm, 1 c
H_2	Case print	50 x 15 mm, 1 c

Art. No. 6151

Set
Twist ball pen 2636 + fountain pen 0104
in presentation box SC 197 with leather
wallet ET 150

BRANDING / AREA

Pens:
see art. 0104, 1119, 2636

Art. No. 6179

Set
Twist ball pen 2636 + rollerball 1119
in presentation box SC 197 with leather
wallet ET 150

Case:		
EB	Embossing	22 x 30 mm

IMAGE® WHITE LINE Ball pen

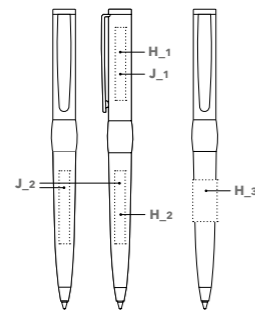

Art. No. 2786

Twist ball pen
Barrel: metal, glossy lacquered
Fittings: Glossy chrome
senator® metal refill, G2
Ink colour: Blue

CORRESPONDING CASES

ET 150, ET 154, ET 156, ET 157, ET 160,
ET 163, ET 169, ET 171, ET 181, SC 197
see page 76-79

COLOURS



BRANDING / AREA

H_1 Metal print 35 x 5 mm
1 colour
H_2 Metal print 35 x 5 mm
1 colour
H_3 Metal print 20 x 12 mm
1 colour

SERVICES

PMS Service: from 5,000 pieces
see page 112

J_1 Laser engraving 35 x 5 mm

J_2 Laser engraving 35 x 5 mm

IMAGE® WHITE LINE Fountain pen

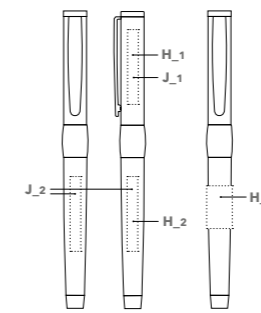

Art. No. 0106

Fountain pen
Barrel: Metal, glossy lacquered
Fittings: Glossy chrome
Iridium-tipped stainless steel nib, M
Standard ink cartridge
Ink colour: Royal blue

CORRESPONDING CASES

ET 150, ET 154, ET 156, ET 157, ET 160,
ET 163, ET 169, ET 171, ET 181, SC 197
see page 76-79

COLOURS



BRANDING / AREA

H_1 Metal print 35 x 5 mm
1 colour
H_2 Metal print 35 x 5 mm
1 colour
H_3 Metal print 20 x 12 mm
1 colour

SERVICES

PMS Service: from 5,000 pieces
see page 112

J_1 Laser engraving 35 x 5 mm

J_2 Laser engraving 35 x 5 mm

IMAGE® WHITE LINE Rollerball

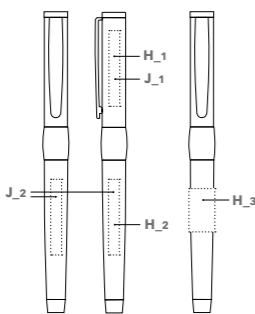

Art. No. 1146

Rollerball
Barrel: metal, glossy lacquered
Fittings: Glossy chrome
Metal safety rollerball refill
Ink colour: Blue

CORRESPONDING CASES

ET 150, ET 154, ET 156, ET 157, ET 160,
ET 163, ET 169, ET 171, ET 181, SC 197
see page 76-79

COLOURS



BRANDING / AREA

H_1 Metal print 35 x 5 mm
1 colour
H_2 Metal print 35 x 5 mm
1 colour
H_3 Metal print 20 x 12 mm
1 colour

SERVICES

PMS Service: from 5,000 pieces
see page 112

J_1 Laser engraving 35 x 5 mm

J_2 Laser engraving 35 x 5 mm

IMAGE® WHITE LINE Sets



6266 + 6267

Art. No. 6266

Set
Twist ball pen 2786 + fountain pen 0106
in white case ET 156

SERVICES

PMS Service: from 5,000 pieces
see page 112

COLOURS



BRANDING / AREA

Pens:
see art. 0106, 1146, 2786

Art. No. 6267

Set
Twist ball pen 2786 + rollerball 1146
in white case ET 156

CARBON LINE

Ball pen



2159

2159

Metal print

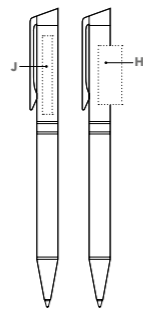

Art. No. 2159

Twist ball pen
Metal in combination with light carbon
Cap, tip, fittings: Metal, matt chrome
senator® metal refill, G2
Ink colour: Blue

CORRESPONDING CASES

ET 150, ET 154, ET 157, ET 160,
ET 163, ET 169, ET 171, ET 181, SC 197
see page 76-79

COLOURS



BRANDING / AREA

H	Metal print	30 x 12 mm	J	Laser engraving	40 x 5 mm
		1 colour			

CARBON LINE

Fountain pen



0076

0076

Metal print

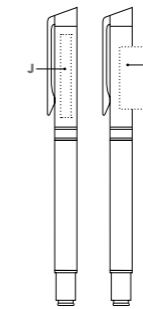

Art. No. 0076

Fountain pen
Metal in combination with light carbon
Cap, tip, fittings: Metal, matt chrome
Iridium-tipped stainless steel nib, M
Standard ink cartridge
Ink colour: Royal blue

CORRESPONDING CASES

ET 150, ET 154, ET 156, ET 157, ET 160,
ET 163, ET 169, ET 171, ET 181, SC 197
see page 76-79

COLOURS



BRANDING / AREA

H	Metal print	30 x 12 mm	J	Laser engraving	40 x 5 mm
		1 colour			

CARBON LINE

Rollerball



1037

1037

Laser engraving

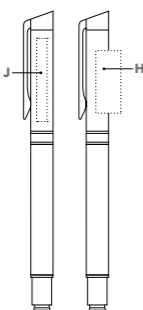

Art. No. 1037

Rollerball
Metal in combination with light carbon
Cap, tip, fittings: Metal, matt chrome
Metal safety rollerball refill
Ink colour: Blue

CORRESPONDING CASES

ET 150, ET 154, ET 156, ET 157, ET 160,
ET 163, ET 169, ET 171, ET 181, SC 197
see page 76-79

COLOURS



BRANDING / AREA

H	Metal print	30 x 12 mm	J	Laser engraving	40 x 5 mm
		1 colour			

CARBON LINE

Sets



6239 + 6240

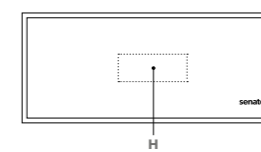

Art. No. 6239

Set
Twist ball pen 2159 + fountain pen 0076
in black case ET 160

Art. No. 6240

Set
Twist ball pen 2159 + Rollerball 1037
in black case ET 160

COLOURS



BRANDING / AREA

Pens: see art. 0076, 1037, 2159	Case: H Case print	50 x 20 mm
		1 colour

TIZIO

Ball pen



2400

2400



Art. No. 2400

Twist ball pen
Barrel: Metal in combination with nutwood
Cap, Tip, fittings: Metal, glossy chrome
senator® metal refill, G2
Ink colour: Blue

CORRESPONDING CASES

ET 150, ET 154, ET 157, ET 160, ET 163,
ET 169, ET 171, ET 181, SC 197
see page 76-79

COLOURS



BRANDING / AREA

J Laser engraving 40 x 5 mm

TIZIO

Rollerball



1240

1240



Art. No. 1240

Rollerball
Barrel: Metal in combination with nutwood
Cap, tip, fittings: Metal, glossy chrome
Metal safety rollerball refill
Ink colour: Blue

CORRESPONDING CASES

ET 150, ET 154, ET 156, ET 157, ET 160,
ET 163, ET 169, ET 181, SC 197
see page 76-79

COLOURS



BRANDING / AREA

J Laser engraving 40 x 5 mm

TIZIO

Fountain pen



0240

0240

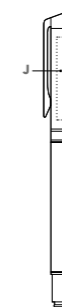

Art. No. 0240

Fountain pen
Barrel: Metal in combination with nutwood
Cap, fittings: Metal, glossy chrome
Iridium-tipped stainless steel nib, M

Standard ink cartridge
Ink colour: Royal blue

CORRESPONDING CASES

ET 150, ET 154, ET 156, ET 157, ET 160,
ET 163, ET 169, ET 181, SC 197
see page 76-79

COLOURS



BRANDING / AREA

J Laser engraving 40 x 5 mm

TIZIO

Sets



6252 + 6253

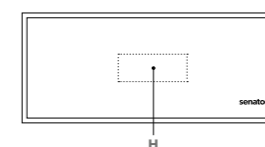

Art. No. 6252

Set
Twist ball pen 1240 + fountain pen 0240
in black case ET 156

Art. No. 6253

Set
Twist ball pen 2159 + rollerball 1240
in black case ET 156

COLOURS



BRANDING / AREA

Writing instruments:
see separate article

Case:
H Case print 50 x 20 mm
1 colour

SOLARIS

Ball pen + rollerball



Laser engraving

Metal print

2479

1479



DESIGNPREIS
2007

NOMINEE

Designpreis der BFD
Design Award of the BFD

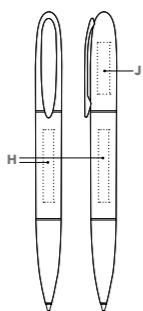

Art. No. 2479

Twist ball pen
Barrel: Metal, textured polished with transparent plastic casing
Fittings: Metal, glossy chrome
senator® metal refill, G2
Ink colour: Blue

CORRESPONDING CASES

ET 150, ET 157, ET 160, ET 163, ET 169,
ET 171, ET 181
see page 76-79

COLOURS



BRANDING / AREA

H Metal print 35 x 5 mm
(not on clear) 1 colour

Art. No. 1479

Rollerball
Barrel: Metal, textured polished with transparent plastic casing
Fittings: Metal, glossy chrome
Metal safety rollerball refill
Ink colour: Blue

SERVICES

PMS Service: from 5,000 pieces
see page 112

J Laser engraving 25 x 6 mm

SOLARIS

Set



6480

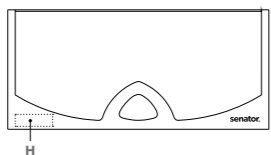

Art. No. 6480

Set
Twist ball pen 2479 + rollerball 1479
in case ET 163

SERVICES

PMS Service: from 5,000 pieces
see page 112

COLOURS



BRANDING / AREA

Pens:
See art. 1479, 2479

Case:
H Case print 25 x 8 mm
1 colour

PRESIDENT

Fountain pen



0125

0122

Engraving of initials



Art. No. 0125

Piston filling fountain pen
Barrel: Acrylic, high gloss
Fittings: Metal, gilt and diamond finish
Iridium tipped stainless steel nib, F, M or B

CORRESPONDING CASES

ET 150, ET 160, ET 168
see page 76-79

COLOURS



BRANDING / AREA

J Engraving of initials 9.7 x 5 mm

PRESIDENT

Sets



5512

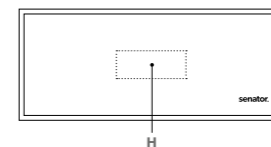

Art. No. 5512

Set
Piston filling fountain pen 0125
in case ET 160

BRANDING / AREA

Fountain pen:
see art. 0125

Case:
H Case print 50 x 20 mm
1 colour



5674

Art. No. 5674

Set
Piston filling fountain pen 0122 and bottle of
royal blue ink in premium gift box ET 168

BRANDING / AREA

Fountain pen:
see art. 0122

CASES



ET 181

Art. No. ET 181

Handy cardboard packaging for the attractive presentation of a ball pen; suitable for all senator® ball pens, white cardboard with a customised 4 colour print

BRANDING / AREA

4c print 166 x 152 mm both sides

Art. No. ET 157

For 1 writing instrument; carton, matt black, at 5,000 pcs. also available in different colours



ET 157

Art. No. ET 169

For 1 writing instrument; plastic, glossy transparent with universal pen holder

BRANDING / AREA

H Case print 60 x 12 mm 1 colour



ET 169

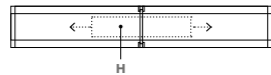

Art. No. ET 171

For 2 writing instruments; Plastic, glossy transparent with universal pen holder

BRANDING / AREA

H Case print 60 x 25 mm 1 colour



ET 171

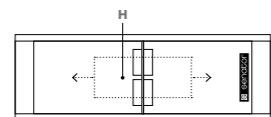

CASES



ET 154

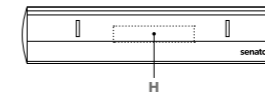

ET 156

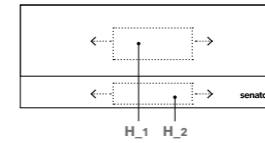

ET 160

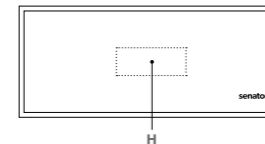

ET 163

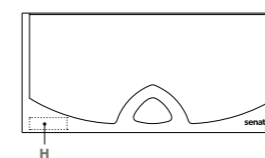

Art. No. ET 154

Suitable for 1 writing instrument; plastic, black/silver with transparent lid, also available for slim writing instruments

BRANDING / AREA

H Case print 50 x 10 mm 1 colour

Art. No. ET 156

For 1 or 2 writing instruments; carded case, black matt or glossy white with magnetic closure and foam inlay

BRANDING / AREA

H_1 Case print 50 x 20 mm 1 colour not on white
H_2 Case print 50 x 15 mm 1 colour not on white

Art. No. ET 160

For 1 or 2 writing instruments; leather look, black with black velour lining

BRANDING / AREA

H Case print 50 x 20 mm 1 colour

Art. No. ET 163

For 1 or 2 writing instruments; plastic, black/silver with decorative lid, black velour lining

BRANDING / AREA

H Case print 28 x 8 mm 1 colour

CASES



ET 150

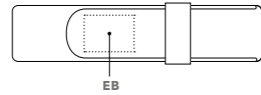

Art. No. ET 150

For 1 or 2 writing instruments;
leather, black

BRANDING / AREA

EB Embossing 30 x 22 mm



SC 197

Art. No. SC 197

For 2 writing instruments;
carton, matt black: including leather
wallet, black

BRANDING / AREA

EB Embossing 30 x 22 mm



ET 168

Art. No. ET 168

Exclusive gift box, includes 1 bottle of
royal blue ink, for 1 piston filling fountain
pen President;
wood, high gloss lacquered, black

CASES

This list indicates which gift case fits which
pen model. The crosses marked in grey are
our recommendations.

	ET 150	ET 154	ET 156	ET 157	ET 160	ET 163	ET 169	ET 171	ET 181	SC 197
Big Pen	x				x	x			x	
Bridge	x	x	x	x	x	x	x	x	x	x
Carbon Line twist ball pen	x	x		x	x	x	x	x	x	
Carbon Line rollerball/fountain pen	x	x	x	x	x	x	x	x	x	
Centrix	x	x			x	x			x	
Challenger	x	x		x	x	x	x	x	x	
Challenger with soft grip	x	x		x	x	x	x		x	
Dart	x	x	x	x	x	x	x	x	x	
Delgado	x	x	x	x	x	x	x	x	x	
Devon	x			x	x	x	x		x	
Duo Pen	x	x	x	x	x	x	x	x	x	
Hatrix	x	x		x	x	x	x	x	x	
Hatrix with soft grip	x			x	x	x	x		x	
Image	x	x	x	x	x	x	x	x	x	x
Liberty®	x	x		x	x	x	x	x	x	
Matrix	x			x	x	x	x		x	
Nature Plus	x	x		x	x	x	x	x	x	
Nautic	x	x	x	x	x	x	x	x	x	x
New Hit	x	x		x	x	x	x	x	x	
New Spring	x	x					x	x	x	
Point	x	x	x	x	x	x	x	x	x	
Polar		x		x	x	x	x	x		x
President	x				x				x	
Signer Liner®	x	x	x		x	x	x	x	x	
Soft Spring	x	x		x	x	x	x		x	
Softstar	x	x	x	x	x	x	x	x	x	
Solaris	x			x	x	x	x	x	x	
Super Hit	x	x		x	x	x	x	x	x	
Super Hit with soft grip	x	x		x	x	x	x		x	
Tizio twist ball pen	x	x		x	x	x	x	x	x	
Tizio rollerball / fountain pen	x		x	x	x	x	x		x	
Visir	x	x	x	x	x	x	x	x	x	



SUBLIMATION

MORE COLOUR. MORE BRILLIANCE.



Brilliant reproduction quality at a top price: **Senator® sublimation printed mugs**. Do you really want to shine with your brand? Then the senator® Pics products are the perfect choice for you. Only senator® offers this unique combination of large-scale sublimation prints and stylish mug designs. You have a choice of nine different mug designs to carry your effective promotional message.

PICS ONE



0323

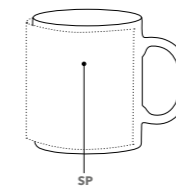

Art. No. 0323

Stoneware mug, glossy white, including sublimation print

DIMENSIONS

Height: ~97 mm
Diameter: ~83 mm
Capacity: ~0.3 l

SERVICES

Packaging, see page 106-107

COLOURS



BRANDING / AREA

SP Sublimation 205 x 90 mm

PICS TWO



0324

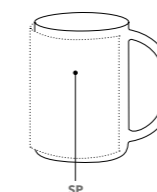

Art. No. 0324

Stoneware mug, glossy white, including sublimation print

DIMENSIONS

Height: ~105 mm
Diameter: ~76 mm
Capacity: ~0.3 l

SERVICES

Packaging, see page 106-107

COLOURS



BRANDING / AREA

SP Sublimation 200 x 95 mm

PICS ELITE



Sublimation

0354

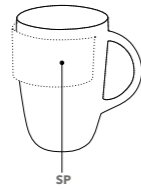

Art. No. 0354

Stoneware mug, glossy white, including sublimation print

DIMENSIONS

Height: ~ 100 mm
Diameter: ~ 82 mm
Capacity: ~ 0.25 l

SERVICES

Packaging, see page 106 - 107

COLOURS



BRANDING / AREA

SP Sublimation 180 x 35 mm

PICS CLASSIC



Sublimation

0362

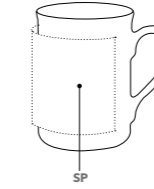

Art. No. 0362

Stoneware mug, glossy white, including sublimation print

DIMENSIONS

Height: ~ 107 mm
Diameter: ~ 80 mm
Capacity: ~ 0.3 l

SERVICES

Packaging, see page 106 - 107

COLOURS



BRANDING / AREA

SP Sublimation 170 x 70 mm

PICS ELITE INSIDE



Sublimation

0355

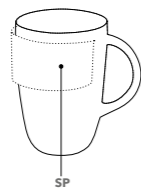

Art. No. 0355

Stoneware mug, glossy white, including sublimation print, with a choice of 4 colours for inside

DIMENSIONS

Height: ~ 100 mm
Diameter: ~ 82 mm
Capacity: ~ 0.25 l

SERVICES

Packaging, see page 106 - 107

COLOURS



BRANDING / AREA

SP Sublimation 180 x 35 mm

PICS SOLID



Sublimation

0358

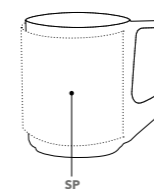

Art. No. 0358

Stoneware mug, glossy white, including sublimation print

DIMENSIONS

Height: ~ 100 mm
Diameter: ~ 82 mm
Capacity: ~ 0.25 l

SERVICES

Packaging, see page 106 - 107

COLOURS



BRANDING / AREA

SP Sublimation 180 x 80 mm

PICS SWEEP



Sublimation

0357

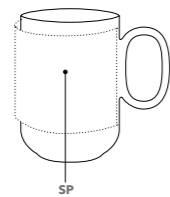

Art. No. 0357

Stoneware mug, glossy white, including sublimation print

DIMENSIONS

Height: ~ 110 mm
Diameter: ~ 75 mm
Capacity: ~ 0.3 l

SERVICES

Packaging, see page 106 - 107

COLOURS



BRANDING / AREA

SP Sublimation 170 x 70 mm

PICS COSMOS



Sublimation

0356

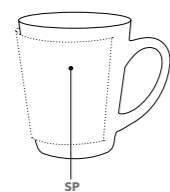

Art. No. 0356

Stoneware mug, glossy white, including sublimation print

DIMENSIONS

Height: ~ 107 mm
Diameter: ~ 95 mm
Capacity: ~ 0.33 l

SERVICES

Packaging, see page 106 - 107

COLOURS



BRANDING / AREA

SP Sublimation 190 x 80 mm

PICS AMITY



Sublimation

0359



Sublimation

0359



Sublimation

0359

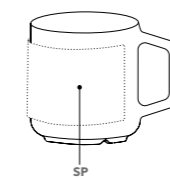

Art. No. 0359

Stoneware mug, glossy white, including sublimation print

DIMENSIONS

Height: ~ 87 mm
Diameter: ~ 78 mm
Capacity: ~ 0.25 l

SERVICES

Packaging, see page 106 - 107

COLOURS



BRANDING / AREA

SP Sublimation 180 x 60 mm



TO GO

MORE FREEDOM. MORE OPTIONS.



On your way to catch the bus, on the train, or in the car, think: **Senator® "To Go"**. Carry your freshly brewed coffee with you wherever you go with our stylish brushed stainless steel travel mugs King Can and Trophy. These thermal mugs are not only easy to fill but also exceedingly tough thanks to a durable screw top. Efficient travel mugs that keep-up with you.

KING CAN



0755

Engraving

Transfer print

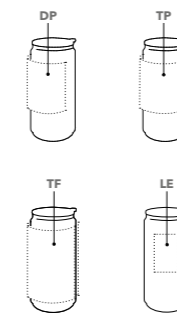

TROPHY



0750

Transfer print partial cover

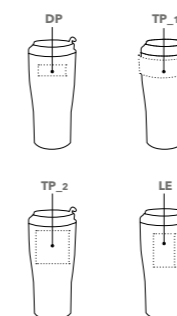

Art. No. 0755

Vacuum thermo mug, double-walled 18/8 stainless steel, including sublimation print, with black plastic lid

DIMENSIONS

Height: ~ 150 mm
Diameter: ~ 71 mm
Capacity: ~ 0.33 l

SERVICES

as standard packed in white cardboard box

COLOURS



Stainless Steel

BRANDING / AREA

DP Direct print	170 x 80 mm, up to 2 colours	TF Transfer print full cover	210 x 115 mm
LE Engraving	12 cm ² (20 x 60 mm)	TP Transfer print partial cover	200 x 80 mm

Art. No. 0750

Vacuum thermo mug, double-walled 18/8 stainless steel, with black plastic lid

DIMENSIONS

Height: ~ 170 mm
Diameter: ~ 82 mm
Capacity: ~ 0.4 l

SERVICES

as standard packed in white cardboard box

COLOURS



Stainless Steel

BRANDING / AREA

DP Direct print	50 x 20 mm up to 2 colours	TP_1 Transfer print full cover	150 x 30 mm
LE Engraving	12 cm ² (20 x 60 mm)	TP_2 Transfer print partial cover	60 x 60 mm

FROZEN MUG



0970

Transfer print full cover

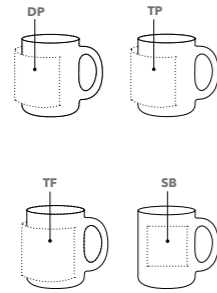

Art. No. 0970

Glass mug, frosted white

DIMENSIONS

Height: ~97 mm
Diameter: ~80 mm
Capacity: ~0.25 l

SERVICES

Glossy Impression, see page 111
Packaging, see page 106-107

COLOURS



BRANDING / AREA

DP Direct print	180 x 65 mm, up to 3 colours	TP Transfer print partial cover	190 x 65 mm
SB Sand blasting	60 x 60 mm	TF Transfer print full cover	220 x 70 mm

PRIME



0341

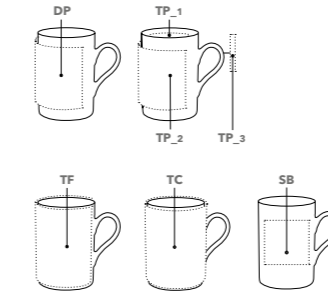

Art. No. 0341

Porcelain mug, glossy white

DIMENSIONS

Height: ~104 mm
Diameter: ~74 mm
Capacity: ~0.25 l

SERVICES

Colour 4U, see page 111-112
Packaging, see page 106-107

COLOURS



BRANDING / AREA

DP Direct print	150 x 70 mm, up to 4 colours	TP_1 Transfer print partial cover	50 x 20 mm
SB Sand blasting	60 x 60 mm	TP_2 Transfer print partial cover	170 x 80 mm
TC Transfer print full cover closed	226 x 100 mm	TP_3 Transfer print partial cover	50 x 5 mm
TF Transfer print full cover	208 x 100 mm		

FROZEN COLOUR



0972

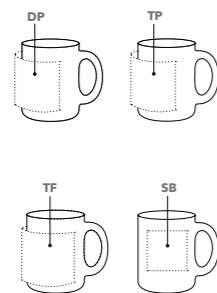

Art. No. 0972

Glass mug, frosted

DIMENSIONS

Height: ~97 mm
Diameter: ~80 mm
Capacity: ~0.25 l

SERVICES

Glossy Impression, see page 111
Packaging, see page 106-107

COLOURS



BRANDING / AREA

DP Direct print	180 x 65 mm, up to 3 colours	TP Transfer print partial cover	190 x 65 mm
SB Sand blasting	60 x 60 mm	TF Transfer print full cover	220 x 70 mm

PRIME COLOUR



0351

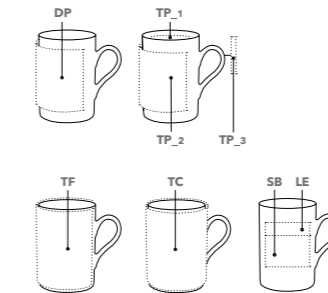

Art. No. 0351

Stoneware mug, glossy coloured

DIMENSIONS

Height: ~105 mm
Diameter: ~75 mm
Capacity: ~0.25 l

SERVICES

Packaging, see page 106-107

COLOURS



BRANDING / AREA

DP Direct print	150 x 70 mm, up to 3 colours	TF Transfer print full cover	208 x 100 mm
LE Engraving	12 cm ² (60 x 20 mm or 40 x 30 mm)	TP_1 Transfer print partial cover	50 x 20 mm
SB Sand blasting	60 x 60 mm	TP_2 Transfer print partial cover	170 x 80 mm
TC Transfer print full cover closed	226 x 100 mm	TP_3 Transfer print partial cover	50 x 5 mm



CLASSIC



Transfer print full cover

Direct print

0973

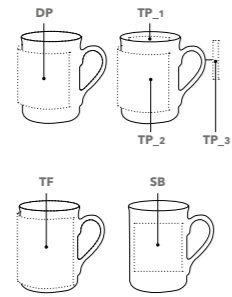

Art. No. 0973
Porcelain mug, glossy white

DIMENSIONS

Height: ~ 104 mm
Diameter: ~ 78 mm
Capacity: ~ 0.25 l

SERVICES

Colour 4U, see page 111-112
Packaging, see page 106-107

COLOURS



BRANDING / AREA

DP Direct print	165 x 70 mm, up to 4 colours	TP_1 Transfer print partial cover	50 x 20 mm
SB Sand blasting	60 x 60 mm	TP_2 Transfer print partial cover	170 x 70 mm
TF Transfer print full cover	210 x 90 mm	TP_3 Transfer print partial cover	50 x 5 mm

SPECIAL



Transfer print partial cover

Transfer print partial cover

0305

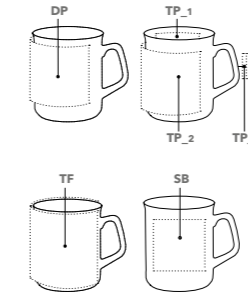

Art. No. 0305
Porcelain mug, glossy white

DIMENSIONS

Height: ~ 95 mm
Diameter: ~ 80 mm
Capacity: ~ 0.3 l

SERVICES

Colour 4U, see page 111-112
Packaging, see page 106-107

COLOURS



BRANDING / AREA

DP Direct print	175 x 60 mm, up to 4 colours	TP_1 Transfer print partial cover	50 x 20 mm
SB Sand blasting	60 x 60 mm	TP_2 Transfer print partial cover	180 x 70 mm
TF Transfer print full cover	225 x 80 mm	TP_3 Transfer print partial cover	30 x 3 mm

CULT



Transfer print full cover

0911

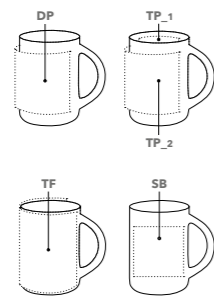

Art. No. 0911
Porcelain mug, glossy white

DIMENSIONS

Height: ~ 105 mm
Diameter: ~ 75 mm
Capacity: ~ 0.25 l

SERVICES

Colour 4U, see page 111-112
Packaging, see page 106-107

COLOURS



BRANDING / AREA

DP Direct print	165 x 70 mm, up to 4 colours	TP_1 Transfer print partial cover	50 x 20 mm
SB Sand blasting	60 x 60 mm	TP_2 Transfer print partial cover	170 x 80 mm
TF Transfer print full cover	208 x 100 mm		

AMITY



Direct print

Colour 4U + Sand blasting

0321

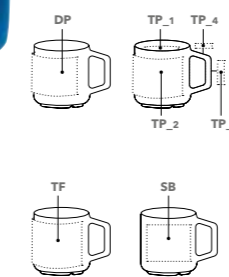

Art. No. 0321
Porcelain mug, glossy white, with water-release indents, suitable for coffee pad machines

DIMENSIONS

Height: ~ 85 mm
Diameter: ~ 80 mm
Capacity: ~ 0.25 l

SERVICES

Colour 4U, see page 111-112
Packaging, see page 106-107

COLOURS



BRANDING / AREA

DP Direct print	170 x 55 mm, up to 4 colours	TP_1 Transfer print partial cover	50 x 20 mm
SB Sand blasting	60 x 50 mm	TP_2 Transfer print partial cover	180 x 60 mm
TF Transfer print full cover	220 x 70 mm	TP_3 Transfer print partial cover	40 x 8 mm
		TP_4 Transfer print partial cover	20 x 8 mm

ELITE



0912

Direct print

Colour 4U + Sand blasting

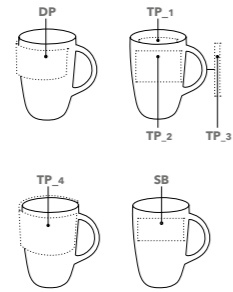

Art. No. 0912

Porcelain mug, glossy white

DIMENSIONS

Height: ~98 mm
Diameter: ~82 mm
Capacity: ~0.25 l

SERVICES

Colour 4U, see page 111-112
Packaging, see page 106-107

COLOURS



BRANDING / AREA

DP Direct print, up to 4 colours	175 x 35 mm	TP_2 Transfer print partial cover	60 x 50 mm
SB Sand blasting	60 x 30 mm	TP_3 Transfer print partial cover	70 x 7 mm
TP_1 Transfer print partial cover	50 x 20 mm	TP_4 Transfer print partial cover	215 x 50 mm

ELITE MATT



0343

Engraving

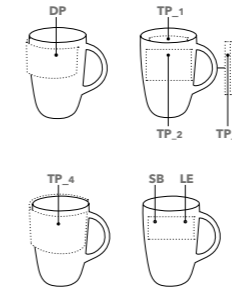

Art. No. 0343

Stoneware mug, matt coloured

DIMENSIONS

Height: ~99 mm
Diameter: ~81 mm
Capacity: ~0.25 l

SERVICES

Packaging, see page 106-107

COLOURS



BRANDING / AREA

DP Direct print, up to 3 colours	175 x 35 mm	TP_1 Transfer print partial cover	50 x 20 mm
LE Engraving	12 cm ² (60 x 20 mm or 40 x 30 mm)	TP_2 Transfer print partial cover	60 x 50 mm
SB Sand blasting	60 x 30 mm	TP_3 Transfer print partial cover	70 x 7 mm
		TP_4 Transfer print partial cover	215 x 50 mm

ELITE INSIDE



0353

Transfer print partial cover

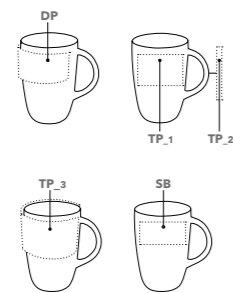

Art. No. 0353

Stoneware mug, glossy white, with a choice of 4 colours for inside

DIMENSIONS

Height: ~99 mm
Diameter: ~81 mm
Capacity: ~0.25 l

SERVICES

Packaging, see page 106-107

COLOURS



BRANDING / AREA

DP Direct print, up to 4 colours	175 x 35 mm	TP_1 Transfer print partial cover	60 x 50 mm
SB Sand blasting	60 x 30 mm	TP_2 Transfer print partial cover	70 x 7 mm
		TP_3 Transfer print partial cover	215 x 50 mm

MAXI MUG



0344

Direct print

Transfer print partial cover

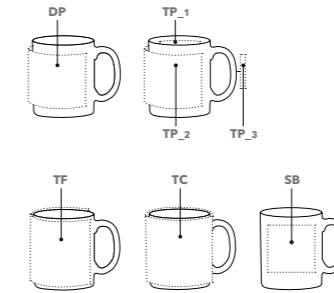

Art. No. 0344

Porcelain mug, glossy white

DIMENSIONS

Height: ~96 mm
Diameter: ~82 mm
Capacity: ~0.25 l

SERVICES

Colour 4U, see page 111-112
Packaging, see page 106-107

COLOURS



BRANDING / AREA

DP Direct print	165 x 70 mm, up to 4 colours	TP_1 Transfer print partial cover	50 x 20 mm
SB Sand blasting	60 x 60 mm	TP_2 Transfer print partial cover	170 x 70 mm
TF Transfer print full cover	210 x 89 mm	TP_3 Transfer print partial cover	45 x 6 mm
TC Transfer print full cover closed	234 x 89 mm		

MAXIM



Transfer print partial cover

0914

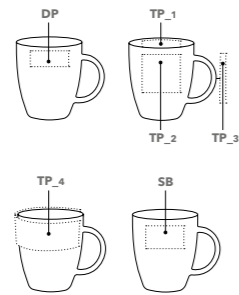

Art. No. 0914
Porcelain mug, glossy white

DIMENSIONS

Height: ~ 100 mm
Diameter: ~ 85 mm
Capacity: ~ 0.30 l

SERVICES

Colour 4U, see page 111-112
Packaging, see page 106-107

COLOURS



BRANDING / AREA

DP Direct print	50 x 20 mm, up to 2 colours	TP_2 Transfer print partial cover	50 x 50 mm
SB Sand blasting	50 x 30 mm	TP_3 Transfer print partial cover	70 x 7 mm
TP_1 Transfer print partial cover	50 x 20 mm	TP_4 Transfer print partial cover	225 x 35 mm

SWEEP



Transfer print full cover

0954

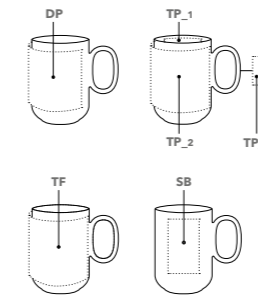

Art. No. 0954
Porcelain mug, glossy white

DIMENSIONS

Height: ~ 108 mm
Diameter: ~ 73 mm
Capacity: ~ 0.25 l

SERVICES

Colour 4U, see page 111-112
Packaging, see page 106-107

COLOURS



BRANDING / AREA

DP Direct print	160 x 70 mm, up to 4 colours	TP_1 Transfer print partial cover	50 x 10 mm
SB Sand blasting	40 x 70 mm	TP_2 Transfer print partial cover	170 x 70 mm
TF Transfer print full cover	208 x 80 mm	TP_3 Transfer print partial cover	40 x 8 mm

MAXIM CAFÉ



Transfer print partial cover

0907

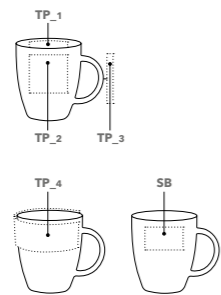

Art. No. 0907
Porcelain mug, glossy white

DIMENSIONS

Height: ~ 81 mm
Diameter: ~ 79 mm
Capacity: ~ 0.2 l

SERVICES

Colour 4U, see page 111-112
Packaging, see page 106-107

COLOURS



BRANDING / AREA

SB Sand blasting	40 x 30 mm	TP_3 Transfer print partial cover	50 x 5 mm
TP_1 Transfer print partial cover	40 x 5 mm	TP_4 Transfer print partial cover	215 x 20 mm
TP_2 Transfer print partial cover	40 x 50 mm		

CHARISMA



Direct print

Transfer print full cover

0915

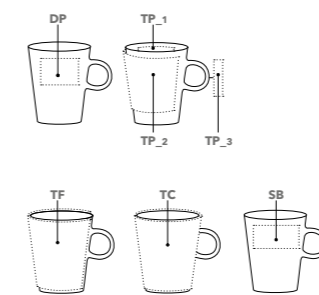

Art. No. 0915
Porcelain mug, glossy white

DIMENSIONS

Height: ~ 100 mm
Diameter: ~ 82 mm
Capacity: ~ 0.25 l

SERVICES

Colour 4U, see page 111-112
Packaging, see page 106-107

COLOURS



BRANDING / AREA

DP Direct print	50 x 35 mm, up to 2 colours	TP_1 Transfer print partial cover	50 x 20 mm
SB Sand blasting	60 x 30 mm	TP_2 Transfer print partial cover	180 x 85 mm
TF Transfer print full cover	200 x 96 mm	TP_3 Transfer print partial cover	50 x 12 mm
TC Transfer print full cover closed	233 x 96 mm		

SOLID



Transfer print partial cover

Transfer print full cover

0944

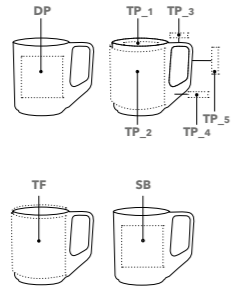

Art. No. 0944

Porcelain mug, glossy white

DIMENSIONS

Height: ~ 97 mm
Diameter: ~ 79 mm
Capacity: ~ 0.25 l

SERVICES

Colour 4U, see page 111 - 112
Packaging, see page 106 - 107

COLOURS



BRANDING / AREA

DP Direct print	60 x 60 mm, up to 2 colours	TP_2 Transfer print partial cover	180 x 80 mm
SB Sand blasting	60 x 60 mm	TP_3 Transfer print partial cover	25 x 8 mm
TF Transfer print full cover	210 x 88 mm	TP_4 Transfer print partial cover	30 x 8 mm
TP_1 Transfer print partial cover	50 x 15 mm	TP_5 Transfer print partial cover	45 x 8 mm

CLUB



Transfer print partial cover

0340

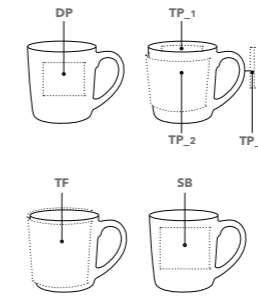

Art. No. 0340

Porcelain mug, glossy white, suitable for coffee pad machines

DIMENSIONS

Height: ~ 86 mm
Diameter: ~ 82 mm
Capacity: ~ 0.25 l

SERVICES

Colour 4U, see page 111 - 112
Packaging, see page 106 - 107

COLOURS



BRANDING / AREA

DP Direct print	50 x 40 mm, up to 4 colours	TP_1 Transfer print partial cover	50 x 20 mm
SB Sand blasting	60 x 50 mm	TP_2 Transfer print partial cover	180 x 60 mm
TF Transfer print full cover	215 x 78 mm	TP_3 Transfer print partial cover	50 x 5 mm

AURIS



Colour 4U + Direct print

Transfer print partial cover

0929

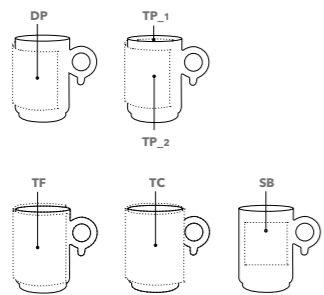

Art. No. 0929

Porcelain mug, glossy white, stackable

DIMENSIONS

Height: ~ 110 mm
Diameter: ~ 77 mm
Capacity: ~ 0.3 l

SERVICES

Colour 4U, see page 111 - 112
Packaging, see page 106 - 107

COLOURS



BRANDING / AREA

DP Direct print	175 x 70 mm, up to 4 colours	TC Transfer print full cover closed	238 x 97 mm
SB Sand blasting	60 x 60 mm	TP_1 Transfer print partial cover	50 x 20 mm
TF Transfer print full cover	220 x 97 mm	TP_2 Transfer print partial cover	180 x 80 mm

VERTIC



Colour 4U + Transfer print partial cover

Transfer print partial cover

0936

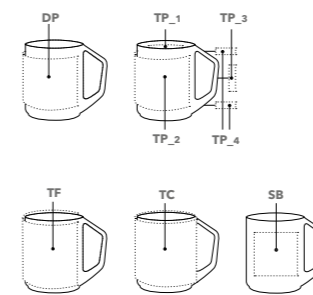

Art. No. 0936

Porcelain mug, glossy white

DIMENSIONS

Height: ~ 100 mm
Diameter: ~ 79 mm
Capacity: ~ 0.3 l

SERVICES

Colour 4U, see page 111 - 112
Packaging, see page 106 - 107

COLOURS



BRANDING / AREA

DP Direct print	170 x 65 mm, up to 4 colours	TP_1 Transfer print partial cover	50 x 20 mm
SB Sand blasting	60 x 60 mm	TP_2 Transfer print partial cover	180 x 70 mm
TC Transfer print full cover closed	246 x 89 mm	TP_3 Transfer print partial cover	40 x 10 mm
TF Transfer print full cover	220 x 89 mm	TP_4 Transfer print partial cover	30 x 10 mm

APPEAL



Transfer print partial cover

Colour 4U + Transfer print partial cover

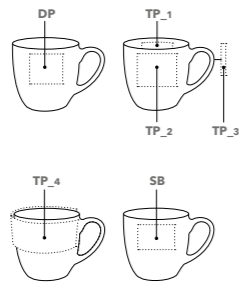

0928

Art. No. 0928

Porcelain mug, glossy white

DIMENSIONS

Height: ~ 94 mm
Diameter: ~ 100 mm
Capacity: ~ 0.4 l

SERVICES

Colour 4U, see page 111-112
Packaging, see page 106-107

COLOURS



BRANDING / AREA

DP Direct print	50 x 45 mm, up to 2 colours	TP_2 Transfer print partial cover	60 x 50 mm
SB Sand blasting	60 x 40 mm	TP_3 Transfer print partial cover	50 x 5 mm
TP_1 Transfer print partial cover	50 x 20 mm	TP_4 Transfer print partial cover	270 x 45 mm

PURITY



Transfer print partial cover

0968

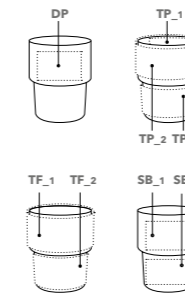

Art. No. 0968

Porcelain mug without handle, glossy white, stackable

DIMENSIONS

Height: ~ 105 mm
Diameter: ~ 86 mm
Capacity: ~ 0.3 l

SERVICES

Colour 4U, see page 111-112
Packaging, see page 106-107

COLOURS



BRANDING / AREA

DP Direct print	60 x 40 mm, up to 4 colours	TF_2 Transfer print full cover	215 x 43 mm
SB_1 Sand blasting	60 x 40 mm	TP_1 Transfer print partial cover	50 x 20 mm
SB_2 Sand blasting	60 x 35 mm	TP_2 Transfer print partial cover	180 x 40 mm
TF_1 Transfer print full cover	265 x 50 mm	TP_3 Transfer print partial cover	180 x 30 mm

COSMOS



Transfer print partial cover

Transfer print full cover

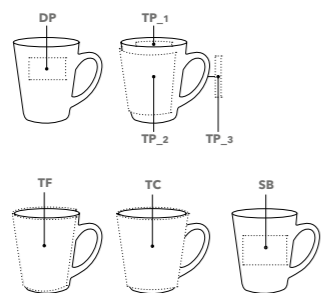

0926

Art. No. 0926

Porcelain mug, glossy white

DIMENSIONS

Height: ~ 106 mm
Diameter: ~ 95 mm
Capacity: ~ 0.33 l

SERVICES

Colour 4U, see page 111-112
Packaging, see page 106-107

COLOURS



BRANDING / AREA

DP Direct print	50 x 30 mm, up to 2 colours	TP_1 Transfer print partial cover	50 x 20 mm
SB Sand blasting	60 x 40 mm	TP_2 Transfer print partial cover	190 x 80 mm
TC Transfer print full cover closed	270 x 103 mm	TP_3 Transfer print partial cover	60 x 8 mm
TF Transfer print full cover	230 x 103 mm		

PURITY PLUS



Transfer print partial cover

0368

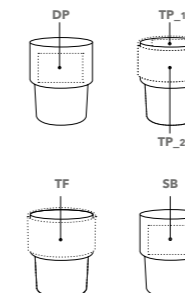

Art. No. 0368

Porcelain mug without handle, glossy white, with a choice of 4 coloured decorative sleeves, stackable

DIMENSIONS

Height: ~ 105 mm
Diameter: ~ 86 mm
Capacity: ~ 0.3 l

SERVICES

Colour 4U, see page 111-112
Packaging, see page 106-107
PMS Service:
decorative sleeve: from 1,000 pcs.

COLOURS

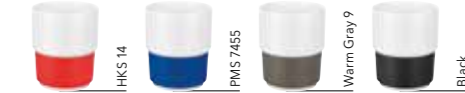

BRANDING / AREA

DP Direct print	60 x 40 mm, up to 4 colours	TP_1 Transfer print partial cover	50 x 20 mm
SB Sand blasting	60 x 40 mm	TP_2 Transfer print partial cover	180 x 40 mm
TF Transfer print full cover	265 x 50 mm		

FANCY Espresso Set + Espresso Duo



0964+0984

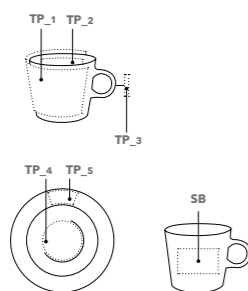

Art. No. 0964

Espresso Set
Porcelain espresso cup and saucer,
glossy white

DIMENSIONS

Height: ~ 57 mm
Diameter: ~ 67 mm
Capacity: ~ 0.13 l
Diameter saucer: ~ 120 mm

COLOURS



BRANDING / AREA

SB Sand blasting	40 x 15 mm	TP_3 Transfer print partial cover	30 x 3 mm
TP_1 Transfer print partial cover	170 x 55 mm	TP_4 Transfer print partial cover	Ø 45 mm
TP_2 Transfer print partial cover	40 x 5 mm	TP_5 Transfer print partial cover	50 x 15 mm

Art. No. 0984

Espresso Duo
2 porcelain espresso cups and saucers,
glossy white, in gift box

FANCY Plates



0966

0993

0994

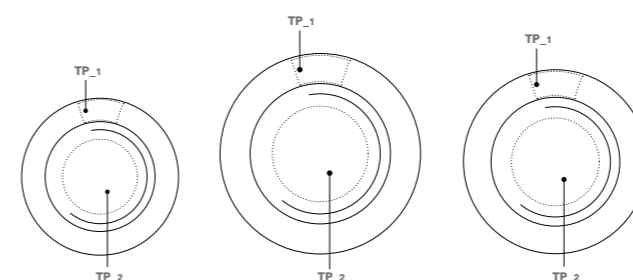

Art. No. 0966

Porcelain plate, glossy white

Art. No. 0993

Porcelain dinner plate, glossy white

DIMENSIONS

Diameter plate: ~ 213 mm
Diameter dinner plate: ~ 263 mm
Diameter soup plate: ~ 225 mm

COLOURS



BRANDING / AREA 0966

TP_1 Transfer print partial cover	40 x 20 mm	TP_2 Transfer print partial cover	Ø 100 mm
--	------------	--	----------

BRANDING / AREA 0993

TP_1 Transfer print partial cover	100 x 20 mm	TP_2 Transfer print partial cover	Ø 100 mm
--	-------------	--	----------

BRANDING / AREA 0994

TP_1 Transfer print partial cover	80 x 20 mm	TP_2 Transfer print partial cover	Ø 100 mm
--	------------	--	----------

FANCY Café Set



0965

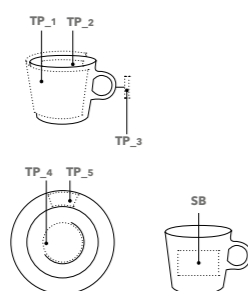

Art. No. 0965

Porcelain cup and saucer, glossy white

DIMENSIONS

Height: ~ 70 mm
Diameter: ~ 82 mm
Capacity: ~ 0.2 l
Diameter saucer: ~ 144 mm

COLOURS



BRANDING / AREA

SB Sand blasting	40 x 30 mm	TP_3 Transfer print partial cover	30 x 5 mm
TP_1 Transfer print partial cover	195 x 60 mm	TP_4 Transfer print partial cover	Ø 55 mm
TP_2 Transfer print partial cover	50 x 20 mm	TP_5 Transfer print partial cover	40 x 20 mm

FANCY Bowl



0920

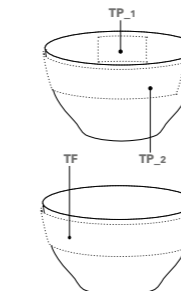

Art. No. 0920

Porcelain bowl, glossy white

DIMENSIONS

Height: ~ 76 mm
Diameter: ~ 141 mm
Capacity: ~ 0.65 l

COLOURS



BRANDING / AREA

TF Transfer print full cover	420 x 30 mm	TP_1 Transfer print partial cover	50 x 30 mm
		TP_2 Transfer print partial cover	210 x 30 mm

FANCY Start-Up Box

Art. No. 0951

Porcelain set of 74 pieces:
24 cups and saucers, 24 plates,
1 milk jug, 1 sugar bowl

DIMENSIONS

Height cup: ~ 70 mm
Diameter cup: ~ 82 mm
Capacity cup: ~ 0.2 l
Diameter saucer: ~ 144 mm
Diameter plate: ~ 210 mm
milk jug: ~ 78 mm
sugar bowl: ~ 58 mm
(with lid ~ 90 mm)



Transfer print
partial cover

0951

COLOURS



BRANDING / AREA

TP_1 Transfer print
partial cover 40 x 20 mm

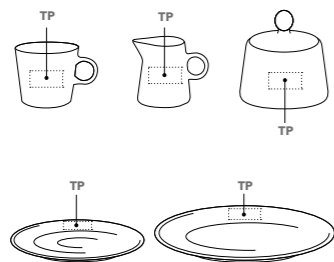

MAXIM Espresso Set + Espresso Duo

Art. No. 0977

Espresso Set
Porcelain espresso cup and saucer,
glossy white

Art. No. 0987

Espresso Duo
2 porcelain espresso cups and saucers,
glossy white, in gift box

DIMENSIONS

Height: ~ 55 mm
Diameter: ~ 60 mm
Capacity: ~ 0.13 l
Diameter saucer: ~ 116 mm

COLOURS



BRANDING / AREA

SB Sand blasting	40 x 15 mm	TP_4 Transfer print partial cover	30 x 3 mm
TP_1 Transfer print partial cover	30 x 40 mm	TP_5 Transfer print partial cover	55 x 15 mm
TP_2 Transfer print partial cover	30 x 5 mm	TP_6 Transfer print partial cover	Ø 25 mm
TP_3 Transfer print partial cover	170 x 10 mm		



Transfer print
partial cover

0977 + 0987

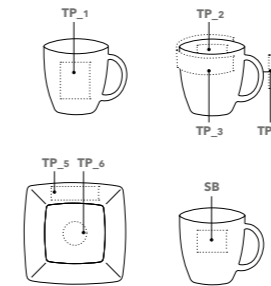

MAXIM Café Set

Art. No. 0937

Porcelain cup and saucer,
glossy white

DIMENSIONS

Height: ~ 81 mm
Diameter: ~ 79 mm
Capacity: ~ 0.2 l
Diameter saucer: ~ 148 mm

COLOURS



BRANDING / AREA

SB Sand blasting	40 x 30 mm	TP_4 Transfer print partial cover	50 x 5 mm
TP_1 Transfer print partial cover	40 x 50 mm	TP_5 Transfer print partial cover	70 x 20 mm
TP_2 Transfer print partial cover	40 x 5 mm	TP_6 Transfer print partial cover	Ø 35 mm
TP_3 Transfer print partial cover	215 x 20 mm		



Transfer print
partial cover

0937

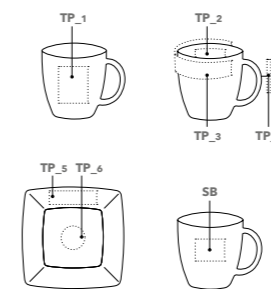

MAXIM Teller



0927



0997



0998

Transfer print
partial cover

Art. No. 0927

Porcelain plate, glossy white

Art. No. 0997

Porcelain dinner plate, glossy white

Art. No. 0998

Porcelain soup plate, glossy white

DIMENSIONS

Diameter plate: ~210 mm
Diameter dinner plate: ~260 mm
Diameter soup plate: ~230 mm

COLOURS



BRANDING / AREA 0927

TP_1 Transfer print partial cover 70 x 25 mm

TP_2 Transfer print partial cover 100 x 100 mm

BRANDING / AREA 0997

TP_1 Transfer print partial cover 100 x 20 mm

TP_2 Transfer print partial cover 100 x 100 mm

BRANDING / AREA 0998

TP_1 Transfer print partial cover 80 x 20 mm

TP_2 Transfer print partial cover 70 x 70 mm

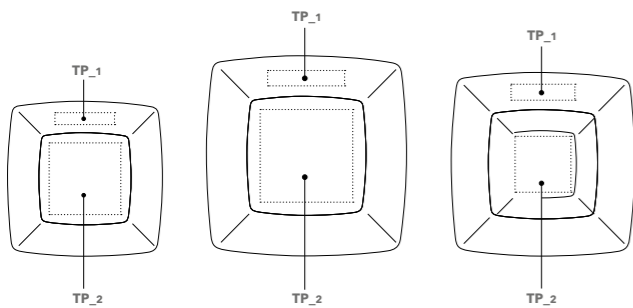

MAXIM Start-Up Box



Transfer print
partial cover

0952

Art. No. 0952

Porcelain set of 74 pieces:
24 cups and saucers, 24 plates,
1 milk jug, 1 sugar bowl

DIMENSIONS

Height cup: ~81 mm
Diameter cup: ~79 mm
Capacity cup: ~0.2 l
Diameter saucer: ~150 mm
Diameter plate: ~210 mm
Height milk jug: ~79 mm
Height sugar bowl: ~78 mm
(with lid ~115 mm)

COLOURS



BRANDING / AREA

TP Transfer print partial cover 40 x 20 mm

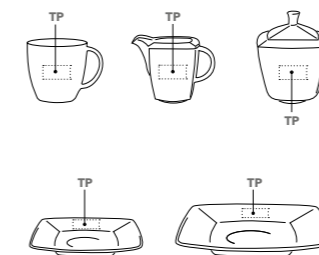

PACKAGING



P1A
P1A XL

Art. No. P1A

Cardboard box, white;
for 1 mug
Size: 125 x 90 x 120 mm

Art. No. P1A XL

Cardboard box, white;
for 1 big mug
Size: 130 x 110 x 120 mm



P1B
P1B XL

Art. No. P1B

Cardboard box, white; with viewing
window; for 1 mug
Size: 115 x 93 x 120 mm

Art. No. P1B XL

Cardboard box, white; with viewing
window; for 1 big mug
Size: 115 x 115 x 125 mm



P2
P2 XL

Art. No. P2

Cardboard box, white;
for 2 mugs
Size: 220 x 90 x 120 mm

Art. No. P2 XL

Cardboard box, white;
for 2 big mugs
Size: 225 x 115 x 115 mm



P4

Art. No. P4

Cardboard box,
white; for 4 mugs
Size: 220 x 120 x 220 mm

PACKAGING



P6

Art. No. P6

Cardboard box, white;
for 6 mugs
Size: 215 x 120 x 325 mm



P36

Art. No. P36

Cardboard box, brown;
for 36 mugs
Size: 540 x 360 x 390 mm



Café set

Espresso set or
duo set

ESPRESSO SET / DUO SET

Cardboard box, white;
for 1 or 2 Espresso Sets
Size: 132 x 110 x 132 mm

CAFÉ SET

Cardboard box, white;
for 1 or 2 Café Sets
Size: 172 x 172 x 155 mm



Packaging slip case

PACKING SLIP CASE

Individually customisable;
sizes and print areas on request

BRANDING METHODS PENS



PROMOTIONAL GIFT
AWARD 2016

HIGH DEFINITION PRINT

Following the strong trend of transforming trade marks and brand designs from a two-dimensional to a three-dimensional look and feel, which in numerous industries is becoming more important, we at senator® invented the worldwide unique High Definition print.

The all-new senator® High Definition print allows unlimited colour shades and unlimited colour gradients. Ask for the High Definition print, which is a worldwide exclusive service and only available by senator®.

The strengths of this branding technique are:

- Palpable 3D-surfaces
- Realisation of complex colour gradients
- Accurate reproduction of photo-realistic themes
- Easy reproduction of multicoloured prints

SCREEN PRINT

Whenever it comes to branding our ball pen barrels or flat clips for us at senator® Screen Print is the branding method of our choice.

The colours used allow a nearly exact reproduction of your corporate colours.

The strengths of this branding technique are:

- Particularly sharp-edged prints
- Large areas printable
- Very precise register accuracy for multi-colour prints

TAMPO PRINT

Tampo Print is particularly suitable for printing on variously shaped or surface structured objects.

We therefore use this printing method for branding our ball pen clips.

The strengths of this branding technique are:

- Best suited to print on curved objects
- Also for printing on small parts

BRANDING METHODS MUGS



BARREL PRINT 360°

When it comes to printing all around our cylindrical barrels the Barrel Print 360° is first choice. As we assemble the ball pen only after the print in this case the barrel can be fully printed even underneath the clip.

Prints with up to 5 colours can be effectively realised.

The strengths of this branding technique are:

- Perfect customisation
- Eye-catching results
- Large print area

METAL PRINT

The surfaces of our metal pens are refined by varnishes, lacquers or other surface coatings.

In order to achieve a good bonding of the ink and wear resistance on these surfaces we use our special Metal Print method. An extra hardening step makes your advertising last longer.

The strengths of this branding technique are:

- Lasts on varnished surfaces
- Brilliant colours

LASER ENGRAVING

For our laser engraving we use a high precision, computer-controlled laser to engrave the surface of our writing instruments and thus expose the metal layer underneath.

This method of branding writing instruments is very durable and makes your advertising last extremely long.

The strengths of this branding technique are:

- A high class and modest result
- Strong with fine lines
- Also suitable for single names

BRANDING METHODS MUGS



DIRECT PRINT

With the Direct Print method we apply the ink directly onto the mug. This saves time and money.

Many of our mug models are suited for up to 4-colour prints, for some models this print method is restricted to 2 colours.

Some print designs cannot be reproduced with the Direct Print method. We will be happy to evaluate your logo prior to printing to make sure this print method is best suited for your project.

The strengths of this branding technique are:

- Short delivery times
- Cost-effective branding method
- Strong with line prints



TRANSFER PRINT, PARTIAL COVER

Transfer Print is a branding method by which we first print the design on a label to be applied onto the mug in a second step. During the firing process the colour combines with the mug surface, the label dissolves up to a small edge around the print design.

The strengths of this branding technique are:

- Endless variety
- Strong with half-tone prints
- Nearly perfect with colour gradients



TRANSFER PRINT, FULL COVER

The Full Cover version of our transfer print is applied onto a considerably larger area.

For all products that are suited for this large area branding please refer to our product pages in this catalogue.

The strengths of this branding technique are:

- Full cover print
- Perfect customisation method
- Large branding area.



TRANSFER PRINT, FULL COVER CLOSED

Some of our mug models can be branded on an even larger area using the additional area around or underneath the handle.

For all products that are suited for this large area branding please refer to our product pages in this catalogue.

The strengths of this branding technique are:

- Use of the complete area
- Perfect customisation

BRANDING METHODS MUGS



SANDBLASTING

With the Sandblasting method we grind the design direct into the surface giving the logo depth and structure.

The strengths of this branding technique are:

- Striking tactile results
- Perfect for coloured mugs
- Provides depth and structure

LASER ENGRAVING

A computer-controlled laser engraves a logo or imprint into the item ensuring absolute definition and longlasting branding.

The strengths of this branding technique are:

- Understated quality
- Precise reproduction of logos and lettering



SUBLIMATION

The sublimation process uses pressure and heat to transfer the graphic onto a specially coated mug.

We offer this impressive branding method for a total of 9 different mug designs.

The strengths of this branding technique are:

- High colour variety and brilliance
- Photo realistic prints possible
- Already available for small quantities from 36 pieces



COLOUR 4U

Name your requested colour and we dye the outside of your mug to your requirements.

This is possible for all white porcelain and stoneware mugs in our senator® range except for our tableware sets.

The strengths of this branding technique are:

- Supremely customisable
- Colour matching on request



GLOSSY IMPRESSION

With this special branding method we treat the frosted glass surface with a special lacquer. This makes the surface clear transparent again resulting in an eye-catching contrast of transparent and frosted surfaces.

The strengths of this branding technique are:

- Patented process
- Unique effects
- Subtle and harmonious

All of our branding methods are suitable for dishwashers. For some branding techniques, such as gold, or our thermo mugs, however, we recommend hand washing. Should you require further information, please contact your senator® customer service team.

COLOUR SERVICE



SENATOR COLOURS

Many of our plastic pens are available in large variety of colours.

This catalogue shows for each product the available colours and surfaces.

The colour specifications conform to the PANTONE® Matching System but the actual product may vary slightly to the shade printed on paper as a result of different surfaces, lighting conditions and materials. Any complaints on such colour deviations can therefore not be accepted. We would be happy to provide you with a sample in advance in the desired plastic shade.

PMS SERVICE

Trouble finding your desired colour in our catalogue products? The PMS service is definitely the right option for you. Because here you can pick the exact shade you're looking for from the variety of possible PMS colours.

Give us the PANTONE® number of your desired colour and we will gladly advise you on prices and delivery times. Certain minimum quantities are required for this service. You can find relevant information with the respective product.

Please also bear in mind possible colour variations between the shade printed on paper and the actual product.

Our metal pens are also available in other colours upon request. The necessary minimum quantities for this can also be found in the technical information.

COLOUR 4U

Even mugs can be individually coloured.

Choose Colour 4U and we will colour the exterior of the mug in an individual colour already at a quantity of 108 pieces.

We dispose of a large variety of ceramic or organic colours to effectually customise your mug in your desired colour.

Combine this brilliant colourful effect with an additional branding such as a print or a sandblasting and transform a white mug into an unmistakable part of your corporate communication.

REFILLS



senator. magic flow

The refill is a decisive part of the ball pen and contributes considerably to the success of the product. Therefore, when choosing a promotional ball pen, its inner values should be a primary consideration.

A high quality refill ensures a more pleasurable writing experience and guarantees higher levels of exposure and a better economic return for brands.

The senator® magic flow refill is one of the best in its class:

- Continuous writing with no spots of ink
- Thanks to a high quality ball and new writing ink in premium quality, this refill offers an extremely smooth and even writing experience
- In two widths:
 - 1.0 mm for all who prefer a clear and fine line
 - 1.4 mm for all who like the lines being a bit stronger
- Indelible to ISO-12757-1 + 2 and tested under stringent quality criteria to the highest demands

BALL PEN REFILLS

Each senator® ball pen is equipped with the perfectly matching refill. We only use tested and standardised quality refills and guarantee:

- Fixed minimum filling quantities for each refill
- Indelibility to ISO-12757-1 + 2
- Compliance with customary refill systems

ROLLERBALL REFILLS

A characteristic of our senator® rollerball refill is the long "Cap-Off" time. A rollerball can easily be left on the table without its cap and will start writing any time.

ARTWORK

GENERAL INFORMATION

Please send us your artwork in the below mention file types or send text in on of our standard typefaces.

We strongly recommend sending data rather than films in order to avoid any loss in quality.

Please also provide a print sample or proof if possible.

Please send logos and text as vectorised files or as TIF-files with 1200 dpi, in case of photos we require a resolution of 600 dpi. Vectorised logos can be scaled without any loss in quality and are to be preferred against pixel files.

Proof samples

To make sure you get the best possible result we recommend the production of a sample for approval. (For production reasons slight colour deviations between a print on paper and a print on other materials are unavoidable).

File formats Mac and PC

Adobe Photoshop CC 2015
Adobe Illustrator CC 2015
Adobe Indesign CC 2015
(Please convert all texts into curves)

Dateiformate PC

Corel Draw X8
(Please convert all texts into curves)

Print positions and dimensions

For all information on print positions and dimensions please refer to the product pages of the catalogue.

PENS

Print colours

With the available colour shade mixing range, all Pantone C and HKS K shades can be mixed. Slight colour shade deviations between paper flags and print are unavoidable on white underground. Major colour shade deviations on an underground of a different colour shade or on a dark-shaded underground must be tolerated.

Digital Print

All colours are mixed in CMYK, so it is not possible to print real PMS colours. In nearly every case the colours will be close to.

Personalisation (list of names)

Many of our products can be customised with the personal name. Please send us the names in an excel file.

Raster

Screen print: Raster of 40, colour intensity 15 - 85%.
360° barrel print: Raster of 48, colour intensity 15 - 85%.

Standard Typefaces

Arial, AvantGarde, Courier, Futura, Present, Serifa, Helvetica, Times New Roman, Univers each regular, bold, italic, bold italic, BrushScript, English script tye each italic and bold italic. Other typefaces possible (only PC), please send font as True Type-face (*.ttf).
Other or similar typefaces on request.

MUGS

Direct Print

Minimum size 10 pt, minimum line width 0.2 mm, no raster

Glass, stainless steel and coloured mugs

Minimum size 12 pt, minimum line width 0.35 mm, printable colour intensity 15 - 85 %

Laser engraving on stainless steel

Minimum size 8 pt, minimum line width 0.2 mm

Laser engraving on coloured mugs

Minimum size 12 pt, minimum line width 0.4 mm

Personalisation (list of names)

A great variety of our mugs can be customised with the personal name. Please send us the names in an excel file. Please note that this very special way of customisation is always possible when the name stands for itself and is not part of the remaining design.

Sandblasting

Minimum size 24 pt, minimum line width 1 mm, no raster

Sublimation

Minimum size: positive 8 pt, negative 10 pt
Minimum line width: positive 0.2 mm, negative 0.3 mm, no raster

Transfer Print

Minimum size 8 pt, minimum line width 0.2 mm, printable colour intensity 15 - 85 %

Valid from Jan. 1, 2017

Whilst our catalogues are prepared with utmost care SENATOR GmbH cannot guarantee the completeness and accuracy of the information provided.

Our general terms apply. You will find these at www.senator.com



HIGH DEFINITION PRINT

MORE CREATIVITY. MORE BRILLIANCE.

The spectacular print you can touch: **Senator® High Definition Print.** Our world-wide unique HD prints impress with raised surfaces and a three-dimensional visual effect. With unlimited colours and gradients to guarantee a visually brilliant brand image.

